



**YAŞAR UNIVERSITY  
GRADUATE SCHOOL OF NATURAL AND APPLIED SCIENCES**

**MASTER THESIS**

**COMPARISON OF LINEAR ORDINARY  
DIFFERENTIAL EQUATIONS SOLUTION METHODS  
AND THEIR APPLICATIONS**

**Cansu AYVAZ**

**Thesis Advisor: Assist. Prof. Dr. Refet POLAT**

**Department of Mathematics**

**Presentation Date: 28.01.2016**

**Bornova-İZMİR**

**2016**



I certify that I have read this thesis and that in my opinion it is fully adequate, in scope and in quality, as a thesis for the degree of Master of Science.

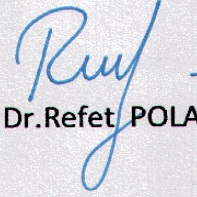

Asst.Prof. Dr.Refet POLAT (Supervisor)

I certify that I have read this thesis and that in my opinion it is fully adequate, in scope and in quality, as a thesis for the degree of Master of Science.

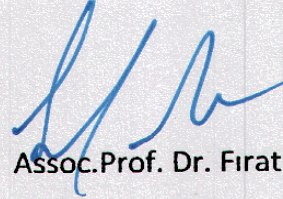

Assoc.Prof. Dr. Firat ATEŞ

I certify that I have read this thesis and that in my opinion it is fully adequate, in scope and in quality, as a thesis for the degree of Master of Science.



Asst.Prof. Dr. Şule Ayar ÖZBAL

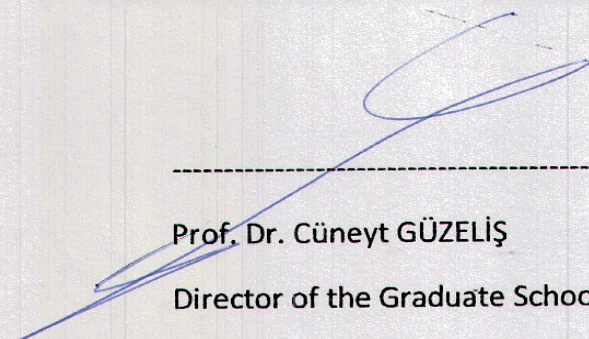

---

Prof. Dr. Cüneyt GÜZELİŞ

Director of the Graduate School



**ABSTRACT**

**COMPARISON OF LINEAR ORDINARY DIFFERENTIAL**

**EQUATIONS SOLUTION METHODS**

**AND THEIR APPLICATIONS**

AYVAZ, Cansu  
M.Sc in Department of Mathematics  
Supervisor: Assist. Prof. Dr. Refet POLAT  
January 2016, 114 pages

In the first section of this thesis, an introduction about the development of differential equation and definitions of the subject are given. In the second chapter, methods that are necessary for reaching the solution of differential equations are given. The method in applied mathematics can be an effective procedure to obtain analytical and approximate solutions for different types of operator. In the third chapter, inspected articles about linear ordinary differential equation, and their synthesis are given. In the fourth chapter, various applications areas of linear ordinary differential equations like economics, biology, mechanics are given. Finally in fifth chapter a conclusion is given.

**Keywords:** Linear Ordinary Differential Equation, Economic problems, Mechanic Problems.

## ÖZET

### LİNEER ADI DİFERANSİYEL DENKLEMLER ÇÖZÜM

### YÖNTEMLERİNİN KARŞILAŞTIRILMASI

### VE UYGULAMALARI

Cansu AYVAZ

Yüksek Lisans, Matematik Bölümü

Tez Danışmanı: Yrd. Doç. Dr. Refet POLAT

Ocak 2016, 114 sayfa

Bu tezin ilk bölümünde diferansiyel denklemlerin oluşumundan bahsedilmiş ve ilgili tanımlar verilmiştir. İkinci bölümünde çözüme ulaşmak için gerekli metotlar vardır. Uygulamalı matematikte yöntem, farklı tipte operatörler için analitik ve yaklaşık çözümler elde etmede etkili bir prosedürdür. Üçüncü bölümde lineer adi diferansiyel denklemler ile ilgili incelenen makaleler, ve sentezi verilmiştir. Dördüncü bölümde ise lineer adi diferansiyel denklemlerin ekonomi, biyoloji, mekanik gibi çeşitli alanlarda uygulamaları verilmiştir. Son olarak beşinci bölümde sonuç verilmiştir.

**Anahtar sözcükler:** Lineer Adi Diferansiyel Denklem, Ekonomi Problemleri, Mekanik Problemler



## **ACKNOWLEDGEMENTS**

I would like to thank to my supervisor Assist. Prof. Dr. Refet POLAT for his support and help on my thesis.

Cansu AYVAZ  
İzmir, 2016

## **TEXT OF OATH**

I declare and honestly confirm that my study, titled “COMPARISON OF LINEAR ORDINARY DIFFERENTIAL EQUATIONS SOLUTION METHODS AND THEIR APPLICATIONS” and presented as a Master’s Thesis, has been written without applying to any assistance inconsistent with scientific ethics and traditions, that all sources from which I have benefited are listed in the bibliography, and that I have benefited from these sources by means of making references.



## TABLE OF CONTENTS

	<b>Page</b>
ABSTRACT	iii
ÖZET	iv
ACKNOWLEDGEMENTS	v
TEXT OF OATH	vi
TABLE OF CONTENTS	vii
INDEX OF FIGURES	xi
INDEX OF TABLES	xii
1 INTRODUCTION	1
1.1 Calculus Review	2
1.1.1 Derivatives	2
1.1.2 Anti-derivatives and Indefinite Integral	6
1.1.3 Definite Integrals	9
1.2 Introduction to Differential Equations	12
1.2.1 Definitions	12
1.2.2 Classifications of Differential Equations	13
1.2.3 Initial Value Problems	16

1.2.4	Modeling a Differential Equation	17
2	REVIEW OF THE LITERATURE	19
2.1	First Order Linear Differential Equations	19
2.1.1	Homogeneous and Nonhomogeneous Equations	19
2.1.2	Solution of Homogenous Equation	20
2.1.3	Solution of The Nonhomogeneous Equation	21
2.1.4	Exact Differential Equations and Integrating Factors	24
2.1.4.1	Exact Differential Equations	24
2.1.4.2	Integrating Factors	26
2.2	Higher Order Linear Differential Equations	26
2.2.1	Introduction	27
2.2.2	Linear Independency and Wronskian Functions	28
2.2.3	Homogeneous Equations Theory	32
2.2.4	Constant Coefficient Homogenous Differential Equations	32
2.2.4.1	The Characteristic Equation	32
2.2.4.2	Multiple Zeros of The Characteristic Equation	36
2.2.5	Nonhomogeneous Equations Theory	40
2.2.5.1	Method of Undetermined Coefficients	40



2.2.5.2	The Method of Variation of The Constants	43
2.2.6	Euler Equations	48
2.3	Linear Differential Equation Systems	52
2.3.1	Elimination Method	56
2.3.2	Eigenvalue Method	58
2.3.2.1	Distinct Real Eigenvalues	61
2.3.2.2	Complex Eigenvalues	64
2.3.3	Comparison of Methods	67
3	INSPECTED ARTICLES	69
3.1	Statistical Modeling of Breast Cancer	69
3.2	Analysis of Economic Growth Differential Equation	77
3.3	Numerical Solution of Vintage Capital Growth Models	83
3.4	Synthesis	86
4	APPLICATIONS OF LINEAR DIFFERENTIAL EQUATIONS	88
4.1	Economic Problems	88
4.2	Biologic Problems	92
4.3	Mechanic Problems	94
4.3.1	Falling Body Problems	94

4.3.2	Spring Problems	101
4.4	Electric Circuits	105
5	CONCLUSION	111
	REFERENCES	112
	CURRICULUM VITEA	114



## INDEX OF FIGURES

Figure 1.1 The slope of the tangent line at $P$ from Weir (2010)	3
Figure 1.2 The curves $y = x^3 + C$ from Weir (2010)	7
Figure 2.1 Direction field of the diff. eq. $y' = y$ from Collatz (1986)	23
Figure 2.2 Direction field of the diff. eq. $y' = y + x$ from Collatz (1986)	23
Figure 2.3 Direction field of the diff. eq. $y' = y + \sin x$ from Collatz (1986)	23
Figure 2.4 Direction field and solution curves for the linear system	64
Figure 3.1 Average Tumor Size x Age tabulation from Tsokos and Xu (2011)	74
Figure 3.2 Tumor Size IROC x Age tabulation from Tsokos and Xu (2011)	75
Figure 4.1 Falling body with air resistance from Bronson and Costa (2006)	95
Figure 4.2 Falling Body from Bronson and Costa (2006)	96
Figure 4.3 Rising body from Bronson and Costa (2006)	98
Figure 4.4 Spring from Bronson and Costa (2006)	101
Figure 4.5 RL Circuit from Bronson and Costa (2006)	107
Figure 4.6 RC Circuit from Bronson and Costa (2006)	107
Figure 4.7 Simple electrical circuit from Bronson and Costa (2006)	108

## INDEX OF TABLES

Table 1.1 Other notations for the derivative (Weir 2010)	4
Table 3.1 Age Group 3 from Tsokos and Xu (2011)	73
Table 3.2 Residuals of Age Group 3 from Tsokos and Xu (2011)	73
Table 3.3 Age Group 3 IROC from Tsokos and Xu (2011)	76
Table 3.4 Residuals of Age Group 3 IROC from Tsokos and Xu (2011)	76

# 1 INTRODUCTION

Mathematics as a science commenced when first someone, probably a Greek, proved propositions about any things or about some things, without specification of definite particular things. These propositions were first enunciated by the Greeks for geometry; and, accordingly, geometry was the great Greek mathematical science. After the rise of geometry centuries passed away before algebra made a really effective start, despite some faint anticipations by the later Greek mathematicians (Whitehead, 1958).

The ideas of any and of some are introduced into algebra by the use of letters, instead of the definite numbers of arithmetic. Thus, instead of saying that  $2+3 = 3+2$ , in algebra we generalize and say that, if  $x$  and  $y$  stand for any two numbers, then  $x+y = y+x$ . Again, in the place of saying that  $3 > 2$ , we generalize and say that if  $x$  be any number there exists some number (or numbers)  $y$  such that  $y > x$ . We may remark in passing that this latter assumption - for when put in its strict ultimate form it is an assumption - is of vital importance, both to philosophy and to mathematics; for by it the notion of infinity is introduced. Perhaps it required the introduction of the Arabic numerals, by which the use of letters as standing for definite numbers has been completely discarded in mathematics, in order to suggest to mathematicians the technical convenience of the use of letters for the ideas of any number and some number. The Romans would have stated the number of the year in which this is written in the form MDCCCX, whereas we write it 1910, thus leaving the letters for the other usage. But this is merely a speculation. After the rise of algebra the differential calculus was invented by Newton and Leibniz, and then a pause in the progress of the philosophy of mathematical thought occurred so far as these notions are concerned; and it was not till within the last few years that it has been realized how fundamental any and some are to the very nature of mathematics, with the result of opening out still further subjects for mathematical exploration (Whitehead, 1958).

In this project, differential calculus is going to be examined. The word Calculus comes from Latin meaning "small stone". Because it is understanding something by looking at small pieces. Differential Calculus cuts something into small pieces to find how it changes. For example, differential calculus helps to know some distance over

some time. This is differential equation. In another saying, differential equations are inescapable to come up with a solution with time dependent scientific problems.

The subject of differential equations constitutes a large and very important branch of modern mathematics. In physics, engineering, chemistry, economics, and other sciences mathematical models are built that involve rates at which things happen. These models are equations and the rates are derivatives. Equations containing derivatives are called differential equations.(Ross,2004)

A review of calculus is given below.

## **1.1 Calculus Review**

In this section, the slope and tangent to a curve at a point, and the derivative of a function at a point are defined. Later in the chapter, the derivative as the instantaneous rate of change of a function is interpreted, and this interpretation applied to the study of certain types of motion. By reviewing Weir (2010).

### **1.1.1 Derivatives**

To find a tangent to an arbitrary curve  $y = f(x)$  at a point  $P(x_0, f(x_0))$ , the slope of the secant through  $P$  and a nearby point  $Q(x_0 + h, f(x_0 + h))$  is calculated. Then the limit of the slope as  $h \rightarrow 0$  (Fig. 1.1) is investigated. If the limit exists, it is called as the slope of the curve at  $P$  and defined as the tangent at  $P$  to be the line through  $P$  having this slope (Weir,2010).

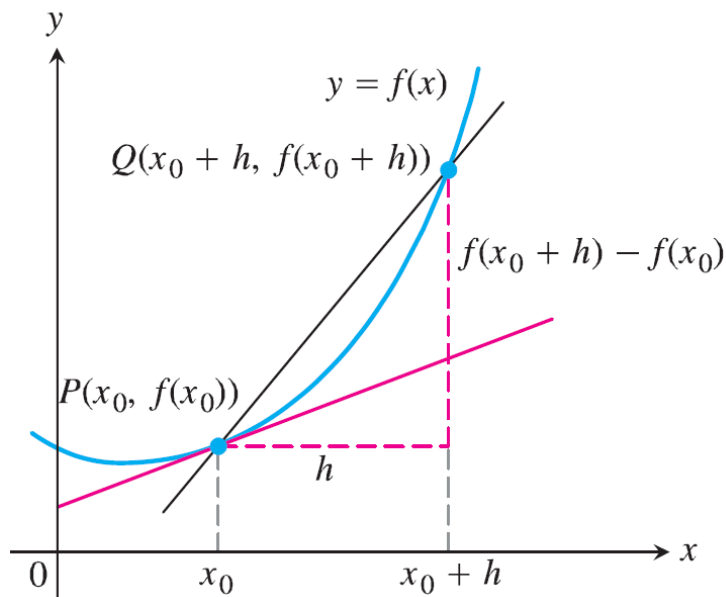

**Figure 1.1** The slope of the tangent line at  $P$  from Weir (2010)

**Definition 1.1:** The *slope of the curve*  $y = f(x)$  at the point  $P(x_0, f(x_0))$  is the number

$$m = \lim_{h \rightarrow 0} \frac{f(x_0 + h) - f(x_0)}{h} \quad (\text{provided the limit exists}).$$

The *tangent line* to the curve at  $P$  is the line through  $P$  with this slope (Weir,2010).

The expression

$$\frac{f(x_0 + h) - f(x_0)}{h}, \quad h \neq 0$$

is called the *difference quotient of  $f$  at  $x_0$  with increment  $h$* . If the difference quotient has a limit as  $h$  approaches zero, that limit is given a special name and notation.

**Definition 1.2:** The derivative of a function  $f$  at a point  $x_0$ , denoted  $f'(x_0)$ , is

$$f'(x_0) = \lim_{h \rightarrow 0} \frac{f(x_0 + h) - f(x_0)}{h}$$

provided this limit exists (Weir,2010).

Other notations for the derivative of a function is given Table below.

Function	Derivative
$f(x)$	$f'(x)$ or $\frac{df(x)}{dx}$
$f$	$f'$ or $\frac{df}{dx}$
$y$	$y'$ or $\frac{dy}{dx}$
$y(x)$	$y'(x)$ or $\frac{dy(x)}{dx}$

**Table 1.1 Other notations for the derivative from Weir (2010)**

A function  $y = f(x)$  is *differentiable on an open interval* (finite or infinite) if it has a derivative at each point of the interval. It is *differentiable on a closed interval*  $[a, b]$  if it is differentiable on the interior  $(a, b)$  and if the limits

$$f'(x_0) = \lim_{h \rightarrow 0^+} \frac{f(a+h) - f(a)}{h} \quad \text{Right-hand derivative at } a$$

$$f'(x_0) = \lim_{h \rightarrow 0^-} \frac{f(b+h) - f(b)}{h} \quad \text{Left-hand derivative at } b$$

exist at the endpoints (Weir,2010).

Right-hand and left-hand derivatives may be defined at any point of a function's domain. According to Weir (2010) a function has a derivative at a point if and only if



it has left-hand and right-hand derivatives there, and these one-sided derivatives are equal.

If  $y = f(x)$  is a differentiable function, then its derivative  $f'(x)$  is also a function. If  $f'$  is also differentiable, then we can differentiate  $f'$  to get a new function of  $x$  denoted by  $f''$ , so  $f'' = (f')'$ . The function  $f''$  is called the *second derivative* of  $f$  because it is the derivative of the first derivative (Weir,2010).

For higher order derivatives the notations are  $y'''(t), y^{(4)}(t), \dots, y^{(n)}(t)$  or  $\frac{d^n}{dt^n} y(t)$  (Weir,2010).

To get a better understanding of subject, at first, derivatives of the most commonly used elementary functions are given below and differentiation rules are given after;

$(t^n)' = nt^{n-1},$		
$(a^t)' = a^t \ln a,$	$(e^t)' = e^t,$	$(\ln t)' = \frac{1}{t},$
$(\sin t)' = \cos t,$	$(\cos t)' = -\sin t,$	$(\tan t)' = \sec^2 t,$
$(\sin^{-1} t)' = \frac{1}{\sqrt{1-t^2}},$	$(\cos^{-1} t)' = \frac{-1}{\sqrt{1-t^2}},$	$(\tan^{-1} t)' = \frac{1}{1+t^2}$

Rules of Differentiation are listed below,

- If  $f$  has the constant value  $f(x) = c$ , then

$$\frac{df}{dx} = \frac{d}{dx}(c) = 0.$$

- If  $n$  is a positive integer, then

$$\frac{d}{dx}x^n = nx^{n-1}.$$

- If  $u$  is a differentiable function of  $x$ , and  $c$  is a constant, then

$$\frac{d}{dx}(cu) = c \frac{du}{dx}.$$

- If  $u$  and  $v$  are differentiable functions of  $x$ , then their sum  $u + v$  is differentiable at every point where  $u$  and  $v$  are both differentiable. At such points,

$$\frac{d}{dx}(u + v) = \frac{du}{dx} + \frac{dv}{dx}.$$

- If  $u$  and  $v$  are differentiable at  $x$ , then so is their product  $uv$ , and

$$\frac{d}{dx}(uv) = u \frac{dv}{dx} + v \frac{du}{dx}.$$

- If  $u$  and  $v$  are differentiable at  $x$  and if  $v(x) \neq 0$ , then the quotient  $u/v$  is differentiable at  $x$ , and

$$\frac{d}{dx}\left(\frac{u}{v}\right) = \frac{v \frac{du}{dx} - u \frac{dv}{dx}}{v^2}$$

(Weir,2010).

### 1.1.2 Anti-derivatives and Indefinite Integral

It have been studied that how to find the derivative of a function. However, many problems require that we recover a function from its known derivative (from its known rate of change). For instance, we may know the velocity function of an object

falling from an initial height and need to know its height at any time. More generally, we want to find a function  $F$  from its derivative  $f$ . If such a function  $F$  exists, it is called an *antiderivative* of  $f$ . We will see in the next chapter that antiderivatives are the link connecting the two major elements of calculus: derivatives and definite integrals (Weir,2010).

**Definition 1.3:** A function  $F$  is an *antiderivative* of  $f$  on an interval  $I$  if  $F'(x) = f(x)$  for all  $x$  in  $I$  (Weir,2010).

Thus the most general antiderivative of  $f$  on  $I$  is a *family* of functions  $F(x) + C$  whose graphs are vertical translations of one another. A particular antiderivative from this family can be selected by assigning a specific value to  $C$ . Here is an example showing how such an assignment might be made;

**Example 1.1:** Find an antiderivative of  $f(x) = 3x^2$  that satisfies  $F(1) = -1$ .

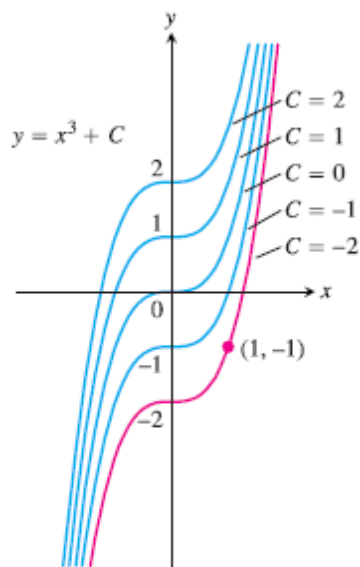

**Figure 1.2** The curves  $y = x^3 + C$  from Weir (2010)

*Solution:* Since the derivative of  $x^3$  is  $3x^2$ , the general antiderivative

$$F(x) = x^3 + C$$

gives all the antiderivatives of  $f(x)$ . The condition  $F(1) = -1$  determines a specific value for  $C$ . Substituting  $x = 1$  into  $F(x) = x^3 + C$  gives

$$F(1) = (1)^3 + C = 1 + C .$$

Since  $F(1) = -1$ , solving  $1 + C = -1$  for  $C$  gives  $C = -2$ . So

$$F(x) = x^3 - 2$$

is the antiderivative satisfying  $F(1) = -1$ . Notice that this assignment for  $C$  selects the particular curve from the family of curves  $y = x^3 + C$  that passes through the point

$(1, -1)$  in the plane (Figure 1.2) (Weir,2010).

A special symbol is used to denote the collection of all antiderivatives of a function  $f$ .

**Definition 1.4:** The collection of all antiderivatives of  $f$  is called the *indefinite integral* of  $f$  with respect to  $x$ , and is denoted by

$$\int f(x)dx .$$

The symbol  $\int$  is an *integral sign*. The function  $f$  is the *integrand* of the integral, and  $x$  is the *variable of integration* (Weir, 2010).

This notation is related to the main application of antiderivatives. According to Weir, (2010) antiderivatives play a key role in computing limits of certain infinite sums, an unexpected and wonderfully useful role, called the Fundamental Theorem of Calculus. It connects integration and differentiation, enabling us to compute integrals using an antiderivative of the integrand function rather than by taking limits of Riemann sums.

### 1.1.3 Definite Integrals

**Definition 1.5:** Let  $f(x)$  be a function defined on a closed interval  $[a, b]$ . We say that a number  $J$  is the *definite integral of  $f$  over  $[a, b]$*  and that  $J$  is the limit of the Riemann sums  $\sum_{k=1}^n f(c_k)\Delta x_k$  if the following condition is satisfied:

Given any number  $\epsilon > 0$  there is a corresponding number  $\delta > 0$  such that for every partition  $P = \{x_0, x_1, \dots, x_n\}$  of  $[a, b]$  with  $\|P\| < \delta$  and any choice of  $c_k$  in  $[x_{k-1}, x_k]$ , we have

$$\left| \sum_{k=1}^n f(c_k)\Delta x_k - J \right| < \epsilon \quad (\text{Weir, 2010}).$$

The definition involves a limiting process in which the norm of the partition goes to zero. In the cases where the subintervals all have equal width  $\Delta x = (b - a)/n$ , we can form each Riemann sum as

$$S_n = \sum_{k=1}^n f(c_k)\Delta x_k = \sum_{k=1}^n f(c_k) \left( \frac{b-a}{n} \right), \quad \Delta x_k = \Delta x = (b-a)/n \text{ for all } k$$

where  $c_k$  is chosen in the subinterval  $\Delta x_k$ . If the limit of these Riemann sums as  $n \rightarrow \infty$  exists and is equal to  $J$ , then  $J$  is the definite integral of  $f$  over  $[a, b]$ , so

$$J = \lim_{n \rightarrow \infty} \sum_{k=1}^n f(c_k) \left( \frac{b-a}{n} \right) = \lim_{n \rightarrow \infty} \sum_{k=1}^n f(c_k)\Delta x. \quad \Delta x = (b-a)/n$$

Leibniz introduced a notation for the definite integral that captures its construction as a limit of Riemann sums. He envisioned the finite sums  $\sum_{k=1}^n f(c_k)\Delta x_k$  becoming an infinite sum of function values  $f(x)$  multiplied by "infinitesimal" subinterval widths  $dx$ . The sum symbol  $\sum$  is replaced in the limit by

the integral symbol  $\int$ , whose origin is in the letter "S." The function values  $f(c_k)$  are replaced by a continuous selection of function values  $f(x)$ . The subinterval widths  $\Delta x_k$  become the differential  $dx$ . It is as if we are summing all products of the form  $f(x)dx$  as  $x$  goes from  $a$  to  $b$ . While this notation captures the process of constructing an integral, it is Riemann's definition that gives a precise meaning to the definite integral (Weir,2010).

The symbol for the number  $J$  in the definition of the definite integral is

$$\int_a^b f(x)dx .$$

After indefinite and definite integrals now Fundamental Theorem of Calculus and rules for integration can be given.

**The Fundamental Theorem of Calculus (FTC):**

**Part 1** If  $f$  is continuous on  $[a, b]$ , then  $f(x) = \int_a^x f(t)dt$  is continuous on  $[a, b]$  and differentiable on  $(a, b)$  and its derivative is  $f(x)$ ;

$$F'(x) = \frac{d}{dx} \int_a^x f(t)dt = f(x) \quad (\text{Weir,2010}).$$

**Part 2** If  $f$  is continuous at every point of  $[a, b]$  and  $F$  is any antiderivative of  $f$  on  $[a, b]$ , then

$$\int_a^b f(x)dx = F(b) - F(a) \quad (\text{Weir, 2010}).$$

**Integration Rules;**

- Zero:

$$\int_a^a f(x)dx = 0 .$$



- Order of Integration

$$\int_b^a f(x)dx = - \int_a^b f(x)dx$$

- Constant Multiples:

$$\int_a^b kf(x)dx = k \int_a^b f(x)dx \quad (\text{Any number } k).$$

$$\int_a^b -f(x)dx = - \int_a^b f(x)dx \quad (k = -1).$$

- Sums and Differences:

$$\int_a^b (f(x) \pm g(x))dx = \int_a^b f(x)dx \pm \int_a^b g(x)dx .$$

- Additivity:

$$\int_a^b f(x)dx + \int_b^c f(x)dx = \int_a^c f(x)dx$$

- Max-Min Inequality: If  $\max f$  and  $\min f$  are the maximum and minimum values of  $f$  on  $[a, b]$ , then

$$\min f * (b - a) \leq \int_a^b f(x)dx \leq \max f * (b - a) .$$

- Domination:

$$f(x) \geq g(x) \text{ on } [a, b] \text{ implies } \int_a^b f(x)dx \geq \int_a^b g(x)dx$$

$$f(x) \geq 0 \text{ on } [a, b] \text{ implies } \int_a^b f(x)dx \geq 0.$$

(Weir,2010).

## 1.2 Introduction to Differential Equations

The study of differential equations has attracted the attention of many of the world's greatest mathematicians during the past three centuries. Nevertheless, it remains a dynamic field of inquiry today, with many interesting open questions. Now detailed informations about differential equations will be given.

### 1.2.1 Definitions

**Definition 1.6:** An equation involving derivatives of one or more dependent variables with respect to one or more independent variables is called a differential equation (Ross, 2004).

Some examples of differential equations listed below.

$$\frac{d^2y}{dx^2} + xy \left(\frac{dy}{dx}\right)^2 = 0, \quad (1.1)$$

$$\frac{d^4x}{dt^4} + 5\frac{d^2x}{dt^2} + 3x = \sin t, \quad (1.2)$$

$$\frac{\partial v}{\partial s} + \frac{\partial v}{\partial t} = v, \quad (1.3)$$

$$\frac{\partial^2 u}{\partial x^2} + \frac{\partial^2 u}{\partial y^2} + \frac{\partial^2 u}{\partial z^2} = 0. \quad (1.4)$$

From the brief list of differential equations examples above it is clear that the various variables and derivatives involved in a differential equation can occur in a variety of ways. Clearly some kind of classification must be made. Therefore, differential equations are classified according to the specified properties which are given below.

### 1.2.2 Classifications of Differential Equations

From the early days of the calculus subject of differential equations has been an area of great theoretical research and practical applications, and it continues to be so in our day. This much stated several questions naturally arise. Just what is a differential equation and what does it signify? Where and how do differential equations originate and of what use are they? Confronted with a differential equation, what does one do with it, how does one do it, and what are the results of such activity? These questions indicate three major aspects of the subject: theory, method, and application (Ross, 2004).

To begin with, differential equations are classified according to whether there is one or more than one independent variable involved.

**Definition 1.7:** A differential equation involving ordinary derivatives of one or more dependent variables with respect to a single independent variable is called an ordinary differential equation (Ross, 2004).

As example, Equations (1.1) and (1.2) are ordinary differential equations. In Equation (1.1) the variable  $x$  is the single independent variable, and  $y$  is a dependent variable. In Equation (1.2) the independent variable is  $t$ , whereas  $x$  is dependent.

**Definition 1.8:** A differential equation involving partial derivatives of one or more dependent variables with respect to more than one independent variable is called a partial differential equation (Ross, 2004).

As example, Equations (1.3) and (1.4) are partial differential equations. In Equation (1.3) the variable  $s$  and  $t$  are independent variables and  $v$  is a dependent variable. In Equation (1.4) there are three independent variables:  $x, y$ , and  $z$ ; in this equation  $u$  is dependent.

Differential equations further classified, both ordinary and partial, according to the order of the highest derivative appearing in the equation. For this purpose following definition is given (Ross,2004).

**Definition 1.9:** The order of the highest ordered derivative involved in a differential equation is called the order of the differential equation (Ross, 2004).

As example, the ordinary differential equation (1.1) is of the second order, since the highest derivative involved is a second derivative. Equation (1.2) is an ordinary differential equation of the fourth order. The partial differential equations (1.3) and (1.4) are of the first and second orders, respectively.

Proceeding with this study of ordinary differential equations, the important concept of linearity applied to such equations is going to be introduced now. This concept will enable these equations to classify still further.

**Definition 1.10:** A linear ordinary differential equation of order  $n$ , in the dependent variable  $y$  and the independent variable  $x$ , is an equation that is in, or can be expressed in, the form

$$a_0(x) \frac{d^n y}{dx^n} + a_1(x) \frac{d^{n-1} y}{dx^{n-1}} + \cdots + a_{n-1}(x) \frac{dy}{dx} + a_n(x)y = b(x),$$

where  $a_0$  is not identically zero.

Observe (1) that the dependent variable  $y$  and its various derivatives occur to the first degree only, (2) that no products of  $y$  and/or any of its derivatives are present, and (3) that no transcendental functions of  $y$  and/or its derivatives occur (Ross,2004).

Several examples of linear differential equations are given below.

The following ordinary differential equations are both linear. In each case  $y$  is the dependent variable. Observe that  $y$  and its various derivatives occur to the first degree only and that no products of  $y$  and/or any of its derivatives are present.

$$\frac{d^2y}{dx^2} + 5\frac{dy}{dx} + 6y = 0, \quad (1.5)$$

$$\frac{d^4y}{dx^4} + x^2\frac{d^3y}{dx^3} + x^3\frac{dy}{dx} = xe^x. \quad (1.6)$$

**Definition 1.11:** A nonlinear ordinary differential equation is an ordinary differential equation that is not linear (Ross, 2004).

Some examples of nonlinear ordinary differential are given below.

$$\frac{d^2y}{dx^2} + 5\frac{dy}{dx} + 6y^2 = 0, \quad (1.7)$$

$$\frac{d^2y}{dx^2} + 5\left(\frac{dy}{dx}\right)^3 + 6y = 0 \quad (1.8)$$

$$\frac{d^2y}{dx^2} + 5y\frac{dy}{dx} + 6y = 0 \quad (1.9)$$

Equation (1.7) is nonlinear because the dependent variable  $y$  appears to the second degree in the term  $6y^2$ . Equation (1.8) owes its nonlinearity to the presence of the term  $5\left(\frac{dy}{dx}\right)^3$ , which involves the third power of the first derivative. Finally, Equation (1.9) is nonlinear because of the term  $5y\left(\frac{dy}{dx}\right)$ , which involves the product of the dependent variable and its first derivative.

Linear ordinary differential equations are further classified according to the nature of the coefficients of the dependent variables and their derivatives (Ross,2004).

**Definition 1.12:** A linear differential equation has constant coefficients if the coefficients of  $y, y', y'', \dots$  are all constants (Ross, 2004).

**Definition 1.13:** A linear differential equation has variable coefficients if the  $y, y', y'', \dots$  are multiplied by any variable (Ross, 2004).

For example, Equation (1.5) is said to be linear with constant coefficients, while Equation (1.6) is linear with variable coefficients.

### 1.2.3 Initial Value Problems

A problem in which we are looking for the unknown function of a differential equation where the values of the unknown function and its derivatives at some point are known is called an initial value problem.

Antiderivatives play several important roles in mathematics and its applications. Methods and techniques for finding them are a major part of calculus. Finding an antiderivative for a function  $f(x)$  is the same problem as finding a function  $y(x)$  that satisfies the equation

$$\frac{dy}{dx} = f(x).$$

This is called a *differential equation*, since it is an equation involving an unknown function  $y$  that is being differentiated. To solve it, we need a function  $y(x)$  that satisfies the equation. This function is found by taking the antiderivative of  $f(x)$ . We fix the arbitrary constant arising in the anti-differentiation process by specifying an initial condition

$$y(x_0) = y_0.$$

This condition means the function  $y(x)$  has the value  $y_0$  when  $x = x_0$ . The combination of a differential equation and initial conditions is called an *initial value problem*. Such problems play important roles in all branches of science (Weir,2010). A simple example is going to be considered for this chapter.

**Example 1.2** Find a solution  $f$  of the differential equation

$$\frac{dy}{dx} = 2x \quad (1)$$

Such that at  $x = 1$  this solution  $f$  has the value 4.



*Explanation and Solution:* First let us be certain that we thoroughly understand this problem. We seek a real function of  $f$  which fulfills the two following requirements:

First, The Function  $f$  must satisfy the differential equation (1). That is, the function  $f$  must be such that  $f'(x) = 2x$  for all real  $x$  in a real interval  $I$ .

Second, The function  $f$  must have the value 4 at  $x = 1$ . That is, the function  $f$  must be such that  $f(1) = 4$ .

Equation (1) has a solution which is written as

$$y = x^2 + c, \quad (2)$$

where  $c$  is an arbitrary constant, and that each of these solutions satisfies the first requirement that is mentioned above. let us now attempt to determine the constant  $c$  so that (2) satisfies the second requirement, that is,  $y = 4$  at  $x = 1$ . Substituting  $x = 1, y = 4$  into (2), we obtain  $4 = 1 + c$ , and hence  $c = 3$ . Now substituting the value  $c = 3$  thus determined back into (2), we obtain

$$y = x^2 + 3,$$

which is indeed a solution of the differential equation (1), which has the value 4 at  $x = 1$ . In other words, the function  $f$  defined by

$$f(x) = x^2 + 3,$$

satisfies both of the requirement set forth in the problem (Ross,2004).

#### 1.2.4 Modeling a Differential Equation

Since many of the fundamental laws of the physical and social sciences involve rates of change, it should not be surprising that such laws are modeled by differential equations (Anton et al., 2012). In this section the general idea of modeling with differential equations is going to be discussed, and in the third and fourth chapter, some important methods that can be applied to population growth, medicine, mechanics, electrics and ecology are going to be investigated.

Differential equations are of interest to nonmathematicians primarily because of the possibility of using them to investigate a wide variety of problems in the physical, biological, and social sciences. One reason for this is that mathematical models and their solutions lead to equations relating the variables and parameters in the problem. These equations often enable you to make predictions about how the natural process will behave in various circumstances. (Boyce and Diprima, 2001).

Recall that a *differential equation* is an equation involving one or more derivatives of an unknown function.

Examples of modeling and applications of differential equations are given in third and fourth chapters more detailed. Now a review of literature is given for solution methods that are being used in differential equations.

## 2 REVIEW OF THE LITERATURE

There are many real life problems that can be modeled by means of differential equations. Especially ordinary differential equations have been used in physical sciences about 17th-18th centuries. Although there are some methods to find the exact solutions of them, it is a well-known fact that any differential equation does not have general solution. For that reason approximate or numerical solutions of differential equation have been studied by researchers for a long time (Kara,2015).

### 2.1 First Order Linear Differential Equations

There are many physical problems that involve a number of separate elements linked together in some manner. For example, electrical networks have this character, as do some problems in mechanics or in other fields. In these and similar cases the corresponding mathematical problem consists of a *system* of two or more differential equations, which can always be written as first order equations. In this chapter systems of *first order linear equations* are given (Boyce and Diproima,2001).

#### 2.1.1 Homogeneous and Nonhomogeneous Equations

Another integrable type of differential equation is the so-called linear differential equation

$$y'(x) + p(x)y = r(x). \quad (2.1)$$

$p(x)$  and  $r(x)$  are given functions, perhaps continuous; for example,  $y' + x^2y = e^2$  is such a linear equation.

If  $y'$  still has a function  $q(x)$  as a factor, the whole equation is to be divided by this function, provided that  $q(x) \neq 0$ .

If the right-hand side  $r(x)$  vanishes identically, the equation is said to be *homogeneous*. Thus  $y' + x^2y = 0$  is the homogeneous equation corresponding to the above example.

But if the right-hand side does not vanish identically, i.e., if  $r(x)^2 \neq 0$ , then the differential equation is said to be *nonhomogeneous*. In such an equation  $r(x)$  is called the 'perturbing function' or the 'perturbing term'.

The nomenclature *homogeneous* and *nonhomogeneous* is analogous to that used for linear systems of algebraic equations. Homogeneous linear systems of equations in algebra always have the so-called 'trivial' solution (all the unknowns are zero), but the 'non-trivial solutions' are of special interest.

The homogeneous linear differential equation

$$y'(x) + p(x)y = 0 \quad (2.2)$$

also has a trivial solution, namely,  $y(x) \equiv 0$ ; its graph is the  $x$ -axis. But there are 'non-trivial solutions' as well, and it is these in which we are much more interested (Collatz, 1986).

### 2.1.2 Solution of Homogenous Equation

Separation of the variables in (2.2) gives

$$\int \frac{dy}{y} = - \int p(x)dx + C_1 .$$

Let  $P(x)$  denote an antiderivative of the integral on the right; then

$$\ln|y| = -P(x) + C_1 .$$

Hence

$$y(x) = C_2 \exp\left(- \int^x p(\xi)d(\xi)\right), \quad y = C_2 e^{-P(x)} .$$

For the sake of clarity the letter  $\xi$  has been used as the variable of integration to distinguish it from the upper limit  $x$  of the integral. It does not matter what lower

limit  $x_0$  is chosen; often 0 is convenient (of course,  $x_0$  must lie in the domain of the function  $p(x)$ ) (Collatz,1986).

**Example 2.1**

$$y' + x^2y = 0$$

The solution is

$$y = C \exp\left(-\int_0^x \xi^2 d\xi\right) = C \exp\left(-\frac{1}{3}x^3\right)$$

or, taking  $x_0$  as the lower limit and writing  $y_0 = y(x_0)$ ,

$$y(x) = y_0 \exp\left(-\int_{x_0}^x \xi^2 d\xi\right) = y_0 \exp\left(\frac{1}{3}(x_0^3 - x^3)\right).$$

For  $C = 0$  or  $y_0 = 0$  we obtain the trivial solution  $y(x) \equiv 0$  (Collatz,1986).

**2.1.3 Solution of The Nonhomogeneous Equation**

The homogeneous equation has the general solution  $y = Ce^{-P(x)}$  with  $C$  as an arbitrary constant. We wish to try to account for the 'distortion' of the solution by the 'perturbing term' by putting  $y = C(x)e^{-P(x)}$ , i.e., we transform the differential equation (2.1) into a new one for the function  $C(x)$ , hoping that the new equation will be simpler. Thus in place of the constant  $C$  a function  $C(x)$ , which is to be determined, appears; the method is therefore known as the method of variation of the constants (Lagrange). From

$$y(x) = C(x) \exp\left(-\int^x p(\xi)d\xi\right)$$

it follows that

$$y'(x) = C'(x) \exp\left(-\int^x p(\xi)d\xi\right) + C(x) \exp\left(-\int^x p(\xi)d\xi\right)(-p(x)).$$

Substitution into the differential equation (2.1) gives

$$C'(x) = r(x) \exp \left[ \int^x p(\xi) d\xi \right].$$

By integrating we obtain immediately

$$C(x) = C_2 + \int^x r(\eta) \exp \left[ \int^\eta p(\xi) d\xi \right] d\eta.$$

So the general solution of the nonhomogeneous linear differential equation (2.1) is

$$y(x) = \exp \left[ - \int^x p(\xi) d\xi \right] \left\{ C + \int^x r(\eta) \exp \left[ \int^\eta p(\xi) d\xi \right] d\eta \right\}.$$

The method of variation of the constants can also be applied to linear differential equations of higher order (Collatz,1986). An example about nonhomogeneous equations is given below.

**Example 2.2** To illustrate the effect of the ‘perturbing function’ we compare the direction fields of the differential equations

$$y' - y = 0 \quad (\text{homogeneous linear})$$

$$\left. \begin{array}{l} y' - y = x \\ y' - y = \sin x \end{array} \right\} (\text{nonhomogeneous linear})$$



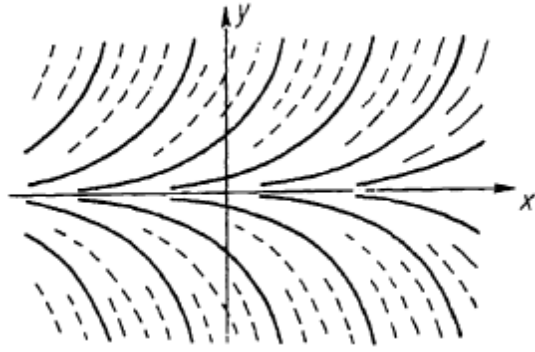

Figure 2.1 Direction field of the diff. eq.  $y' = y$  from Collatz (1986)

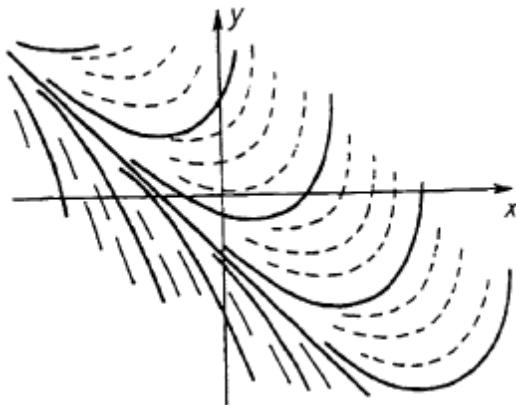

Figure 2.2 Direction field of the diff. eq.  $y' = y + x$  from Collatz (1986)

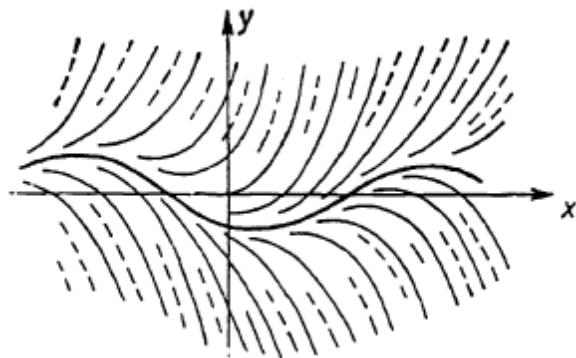

Figure 2.3 Direction field of the diff. eq.  $y' = y + \sin x$  from Collatz (1986)

Their general solutions are:

$$y = Ce^x, \quad \text{Figure 2.1}$$

$$y = Ce^x - 1 - x, \quad \text{Figure 2.2}$$

$$y = Ce^x - \frac{1}{2}\sin x - \frac{1}{2}\cos x, \quad \text{Figure 2.3}$$

(Collatz, 1986).

### 2.1.4 Exact Differential Equations and Integrating Factors

For first order equations there are a number of integration methods that are applicable to various classes of problems. The most important of these are linear equations and separable equations, which is discussed previously. Here, a class of equations known as exact equations is considered for which there is also a well-defined method of solution. Keep in mind, however, that those first order equations that can be solved by elementary integration methods are rather special; most first order equations cannot be solved in this way (Boyce and Diprima, 2001).

#### 2.1.4.1 Exact Differential Equations

Let a differential equation  $y' = \varphi(x, y)$  be written in the form

$$f(x, y)dx + g(x, y)dy = 0.$$

This is called an *exact* differential equation if

$$f(x, y) = \frac{\partial z}{\partial x}, g(x, y) = \frac{\partial z}{\partial y},$$

and then  $z(x, y) = \text{constant} = c$  is the general solution in implicit form. Now it is well known that the mixed second derivatives of a function  $z(x, y)$  are identical with one another provided they are continuous:

$$\frac{\partial^2 z}{\partial x \partial y} = \frac{\partial^2 z}{\partial y \partial x},$$

hence we obtain a simple necessary condition for a differential equation to be exact, viz.,

$$\frac{\partial f}{\partial y} = \frac{\partial g}{\partial x}.$$

However, cases where a differential equation satisfies this condition immediately rarely occur (Collatz, 1986). An example is given below for exact differential equations.

**Example 2.3** Solve the differential equation

$$2x + y^2 + 2xyy' = 0. \quad (1)$$

*Solution* The equation is neither linear nor separable, so the methods suitable for those types of equations are not applicable here. However, observe that the function  $\psi(x, y) = x^2 + xy^2$  has the property that

$$2x + y^2 = \frac{\partial \psi}{\partial x}, \quad 2xy = \frac{\partial \psi}{\partial y}. \quad (2)$$

Therefore the differential equation can be written as

$$\frac{\partial \psi}{\partial x} + \frac{\partial \psi}{\partial y} \frac{dy}{dx} = 0 \quad (3)$$

Assuming that  $y$  is a function of  $x$  and calling upon the chain rule, we can write Equation (3) in the equivalent form

$$\frac{\partial \psi}{\partial x} + \frac{d}{dx}(x^2 + xy^2) = 0.$$

Therefore

$$\psi(x, y) = x^2 + xy^2 = c$$

where  $c$  is an arbitrary constant, is an equation that defines solution of Equation (1) implicitly (Boyce and Diprima, 2001).

#### 2.1.4.2 Integrating Factors

Sometimes, however, a differential equation can easily be changed into an exact differential equation by multiplying it throughout by a suitable, so-called integrating factor  $\mu(x, y)$ . We therefore require of  $\mu(x, y)$  that for

$$\mu(x, y)f(x, y)dx + \mu(x, y)g(x, y)dy = 0$$

the condition

$$\frac{\partial}{\partial y}(\mu f) = \frac{\partial}{\partial x}(\mu g)$$

shall be satisfied, or, differentiating out,

$$\frac{\partial \mu}{\partial x}g - \frac{\partial \mu}{\partial y}f + \mu\left(\frac{\partial g}{\partial x} - \frac{\partial f}{\partial y}\right) = 0.$$

At first sight it seems as if the difficulties have been increased, because now, instead of an ordinary differential equation, we have to solve a partial differential equation for the function  $\mu(x, y)$ . But sometimes a particular solution of this partial differential equation can be guessed, and any one solution (which must, of course, not vanish identically) is all that is needed (Collatz, 1986).

## 2.2 Higher Order Linear Differential Equations

Linear equations of higher order are of crucial importance in the study of differential equations for two main reasons. The first is that linear equations have a rich theoretical structure that underlies a number of systematic methods of solution. Further, a substantial portion of this structure and these methods are understandable at a fairly elementary mathematical level. Another reason to study second and higher order linear equations is that they are vital to any serious investigation of the classical areas of mathematical physics. One cannot go very far in the development of fluid

mechanics, heat conduction, wave motion, or electromagnetic phenomena without finding it necessary to solve second order linear differential equations. For examples see Chapter 4. (Boyce and Diprima,2001)

### 2.2.1 Introduction

A very important type of differential equation of higher order is the linear differential equation. It has, compared to (2.1), the general form

$$p_n(x)y^{(n)} + p_{n-1}(x)y^{(n-1)} + \dots + p_1(x)y' + p_0(x)y = r(x).$$

We also write the entire left-hand side briefly and symbolically as  $L\{y\}$ , thus

$$L[y] \equiv \sum_{v=0}^n p_v(x)y^{(v)} = r(x) \quad (2.3).$$

In this expression the zeroth derivative  $y^{(0)}$  means the function  $y$  itself. The  $p_v$  and  $r$  are given continuous functions of  $x$  in an interval  $[a, b]$ . As in Chapter 2.1.1, we call the differential equation homogeneous if  $r(x) \equiv 0$ , otherwise nonhomogeneous. If  $p_n(x) \neq 0$  in  $(a, b)$ , then we can divide (2.3) by  $p_n(x)$ , and we obtain an equation with continuous coefficients, for which the theorem in is applicable; according to this theorem, if the initial conditions  $y^{(q)}(x_0) = y_0^{(q)}$  for  $q = 0, 1, \dots, n - 1$ , where  $x_0$  must, of course, be in  $(a, b)$ , are prescribed, then the solution  $y(x)$  of the differential equation is uniquely determined. If nothing to the contrary is stated, we shall in the following assume  $p_n(x) \neq 0$  (Collatz,1986).

$L[y]$  is a *linear homogeneous differential expression*, which has these properties: if  $y, z$  are two  $n$ -times continuously differentiable functions and if  $a$  is an arbitrary constant, then

$$L[y + z] = \sum_{v=0}^n p_v(x)\{y^{(v)} + z^{(v)}\} = L[y] + L[z],$$

$$L[ay] = \sum_{v=0}^n p_v(x).ay^{(v)} = aL[y],$$

In particular,

$$L[-y] = -L[y] \quad (\text{Collatz, 1986}).$$

### 2.2.2 Linear Independency and Wronskian Functions

There is a criterion for linear independence of  $n$  solutions  $y_1, \dots, y_n$  of an  $n^{\text{th}}$ -order homogeneous differential equation.

First of all, let  $y_1(x), \dots, y_n(x)$  be any given functions which are  $n - 1$  times continuously differentiable in an interval  $(a, b)$  (Collatz, 1986). Now suppose that these functions are linearly dependent in  $(a, b)$ ; then there are constants  $C_k$ , not all zero, such that the combination

$$y = C_1y_1 + C_2y_2 + \dots + C_ny_n \equiv 0 \quad (2.4)$$

vanishes identically in  $(a, b)$ ; but then the same is true for the derivatives

$$y' = C_1y_1' + C_2y_2' + \dots + C_ny_n' \equiv 0$$

$$\vdots \quad \quad \quad \vdots \quad \quad \quad \vdots \quad \quad \quad \vdots$$

$$y^{(n-1)} = C_1y_1^{(n-1)} + C_2y_2^{(n-1)} + \dots + C_ny_n^{(n-1)} \equiv 0 \quad (2.5).$$

This is a system of  $n$  linear homogeneous equations for the  $n$  quantities  $C_1, C_2, \dots, C_n$ . According to Collatz (1986) it has a non-trivial solution, and so the determinant of the system of equations must have the value zero (at every point  $x$  of the interval); this determinant is called the *Wronskian determinant*, or simply the *Wronskian*:

$$D = \begin{vmatrix} y_1 & y_2 & \dots & y_n \\ y_1' & y_2' & \dots & y_n' \\ \dots & \dots & \dots & \dots \\ y_1^{(n-1)} & y_2^{(n-1)} & \dots & y_n^{(n-1)} \end{vmatrix} \quad (2.6)$$

Now the identical vanishing of the Wronskian is indeed a necessary, but by no means a sufficient, condition for linear dependence of the functions  $y_1, \dots, y_n$ . For example the functions  $y_1 = x^3, y_2 = |x|^3$  defined and continuously differentiable in the interval  $(-1, +1)$  are linearly independent, but nevertheless their Wronskian vanishes identically:

$$\begin{vmatrix} x^3 & x^2 & |x| \\ 3x^2 & 3x & |x| \end{vmatrix} \equiv 0.$$

If, however, it is additionally assumed that the  $y_1, \dots, y_n$  are solutions of a homogeneous differential equation of order  $n$ , then the vanishing of the Wronskian is a criterion for linear dependence. This will now be made more precise.

Let  $y_1(x), \dots, y_n(x)$  be solutions in an interval  $(a, b)$  of the homogeneous differential equation

$$L[y] \equiv \sum_{v=0}^n p_v(x) y^{(v)}(x) = 0, \quad (2.7)$$

where, as before, the  $p_v(x)$  are given continuous functions in  $(a, b)$  with  $p_n(x) \neq 0$ . The Wronskian  $D$  of the functions  $y_k$ , formed as in (2.6), then satisfies a simple differential equation. To set up this equation we form the derivative of  $D$ . A determinant is differentiated by differentiating each row in turn, keeping the other rows unchanged, and adding the  $n$  determinants so formed. Thus

$$\frac{dD}{dx} = \begin{vmatrix} y_1' & \dots & y_n' \\ y_1' & \dots & y_n' \\ y_1'' & \dots & y_n'' \\ \dots & \dots & \dots \\ y_1^{(n-1)} & \dots & y_n^{(n-1)} \end{vmatrix} + \begin{vmatrix} y_1 & \dots & y_n \\ y_1'' & \dots & y_n'' \\ y_1'' & \dots & y_n'' \\ \dots & \dots & \dots \\ y_1^{(n-1)} & \dots & y_n^{(n-1)} \end{vmatrix} + \dots + \begin{vmatrix} y_1 & \dots & y_n \\ y_1' & \dots & y_n' \\ y_1'' & \dots & y_n'' \\ \dots & \dots & \dots \\ y_1^{(n)} & \dots & y_n^{(n)} \end{vmatrix}$$

The first  $(n - 1)$  determinants on the right vanish, because in each there are two identical rows; so only the last determinant remains. In it we multiply the last row by  $p_n(x)$ , so that the value of the determinant is likewise multiplied by  $p_n(x)$ ; then we multiply the first row by  $p_0(x)$ , the second row by  $p_1(x)$ , and so on, and finally the  $(n-1)$ th row by  $p_{n-2}(x)$ , and add the products to the  $n^{\text{th}}$  row; the value of

the determinant is unchanged by so doing. The terms in the last row are thus replaced by

$$p_n(x)y_k^{(n)} + \sum_{v=0}^{n-2} p_v(x)y_k^{(v)}. \quad (k = 1, \dots, n)$$

But from the differential equation (2.7) this is precisely equal to  $-p_{n-1}(x)y_k^{(n-1)}$ , and so we can take the factor  $-p_{n-1}$ , outside the determinant and thus obtain the original Wronskian; so

$$\frac{dD}{dx} = -\frac{p_{n-1}(x)}{p_n(x)}D.$$

This linear differential equation of the first order for  $D$  has the solution

$$D(x) = D(x_0) \exp\left(-\int_{x_0}^x \frac{p_{n-1}(s)}{p_n(s)} ds\right), \quad (\text{where } \exp(x) = e^x) \quad (2.8)$$

Here  $x_0$  is an arbitrarily chosen point in  $(a, b)$ . If, therefore,  $D = 0$  (resp.  $\neq 0$ ) at a point  $x_0$ , then  $D = 0$  (resp.  $D \neq 0$ ) throughout the entire interval  $(a, b)$ , since the exponential factor is always  $\neq 0$ ; the Wronskian of the  $n$  solutions  $y_1, \dots, y_n$  either vanishes identically or vanishes nowhere in the interval  $(a, b)$ . It was proved earlier that if the  $y_k$  are linearly dependent in  $(a, b)$  then  $D$  vanishes identically. But the converse also holds: if  $D$  vanishes at a point in  $(a, b)$  (and therefore identically), then the  $y_k$  are linearly dependent in  $(a, b)$ . Since  $D(x_0) = 0$ , the system of equations (2.4), (2.5) written for the point  $x_0$  has a non-trivial solution  $C_1, \dots, C_n$ , and the function

$$\varphi(x) = \sum_{k=1}^n C_k y_k(x)$$

formed using these constants is a solution of the homogeneous differential equation, with the initial values at the point  $x_0$

$$\varphi(x_0) = \varphi'(x_0) = \dots = \varphi^{(n-1)}(x_0) = 0.$$



But this initial-value problem has the solution  $y \equiv 0$ , and since the initial-value problem has a unique solution, we must have  $\varphi = 0$  in  $(a, b)$ , i.e., the solutions  $y_k(x)$  are linearly dependent. So the following theorem holds (Collatz,1986).

**Theorem 2.1**  $n$  solutions  $y_1(x), \dots, y_n(x)$  of a homogeneous linear  $n^{\text{th}}$ -order differential equation (2.7) with continuous coefficients  $p_n(x)$  and  $p_n(x) \neq 0$  in an interval  $(a, b)$  form a fundamental system, i.e., are linearly independent, if and only if their Wronskian (2.6) is different from zero at an arbitrarily chosen point  $x_0$  of the interval (Collatz,1986).

And an example of this chapter is below.

**Example 2.4** It can be shown immediately by substitution that (for  $\omega \neq 0$ )

$$y_1 = \cos \omega x \quad \text{and} \quad y_2 = \sin \omega x$$

satisfy the differential equation

$$y'' + \omega^2 y = 0, \quad (1)$$

their Wronskian at, say, the point  $x = 0$ , is non-zero:

$$\begin{vmatrix} 1 & 0 \\ 0 & \omega \end{vmatrix} = \omega \neq 0,$$

so the general solution of (1) reads

$$y = C_1 \cos \omega x + C_2 \sin \omega x$$

a normalized fundamental system for the point  $x = 0$  is formed by the functions

$$\bar{y}_1 = \cos \omega x, \bar{y}_2 = \frac{1}{\omega} \sin \omega x;$$

is the solution of the initial-value problem for (1) with the initial conditions  $y(0) = y_0, y'(0) = y'_0$  (Collatz,1986).

### 2.2.3 Homogeneous Equations Theory

Let us look the solution of  $y'' = 0$  differential equation. Assuming that general solution of  $y = c_1x + c_2$ ,  $y_1 = x$  and  $y_2 = 1$ , we can figure  $y = c_1y_1 + c_2y_2$  (Çengel,2013). According to this, we can write the principle of superposition below.

“If  $y_1$  and  $y_2$  are the solution of a linear homogenous differential equation ( $y'' + P(x)y' + Q(x)y = 0$ ),  $y = c_1y_1 + c_2y_2$  is also a solution of the equation. “

#### **Theorem 2.2 Principle of Superposition**

$y'' + P(x)y' + Q(x)y = 0$  equation, for  $P(x)$  and  $Q(x)$  that is continuous in  $x_1 < x < x_2$  gap, always  $y_1$  and  $y_2$  have linear independent two solutions. Besides that any solutions in this gap as a linear combination of these two solutions;

$$y = c_1y_1 + c_2y_2$$

can be figured this way (Çengel,2013).

### 2.2.4 Constant Coefficient Homogenous Differential Equations

In this section the special case of the  $n^{\text{th}}$  order homogeneous linear differential equation is considered in which all of the coefficients are real constants. That is, Eq. (2.9) is going to be concerned about. In this chapter, it is going to be shown that the general solution of this equation can be found explicitly.

#### 2.2.4.1 The Characteristic Equation

Among linear differential equations those with constant coefficients  $p_v$  (and  $p_n \neq 0$ ) are particularly important:

$$L[y] \equiv \sum_{v=0}^n p_v y^{(v)}(x) = r(x).$$

They turn up very often in applications and their general solution can always be determined by quadrature.

The earlier example of the differential equation  $y' - ky = 0$  with its solution  $y = Ce^{kx}$  suggests to us that for the homogeneous equation  $(r(x) \equiv 0)$

$$L[y] \equiv \sum_{v=0}^n p_v y^{(v)}(x) = 0 \quad (2.9)$$

we should seek a substitution

$$y = e^{kx}, \quad y' = ke^{kx}, \dots, y^{(n)} = k^n e^{kx}$$

where the  $k$  is still to be determined.

Since  $e^{kx}$  is not zero for any finite exponent, we can divide through by  $e^{kx}$  and thus obtain the so-called characteristic equation:

$$P(k) \equiv p_n k^n + p_{n-1} k^{n-1} + \dots + p_1 k + p_0 = 0 \quad (2.10).$$

This is an algebraic equation of the  $n^{\text{th}}$  degree for  $k$ . Formally, we obtain it from the differential equation by replacing  $y^{(v)}$  by  $k^v$ .

Suppose its  $n$  roots are

$$k_1, k_2, \dots, k_n.$$

We consider first the case where all the roots are distinct. Complex roots may occur. The further treatment when there are complex roots is given later.

So now there are  $n$  different particular solutions

$$y_1 = e^{k_1 x}, \quad y_2 = e^{k_2 x}, \dots, y_n = e^{k_n x}.$$

These form a fundamental system, as can be established by evaluating the Wronskian  $D$ . We form  $D$  at the point  $x = x_0$  say:

$$\begin{aligned}
 D &= \begin{vmatrix} 1 & 1 & \dots & 1 \\ k_1 & k_2 & \dots & k_n \\ k_1^2 & k_2^2 & \dots & k_n^2 \\ \dots & \dots & \dots & \dots \\ k_1^{n-1} & k_2^{n-1} & \dots & k_n^{n-1} \end{vmatrix} \\
 &= \prod_{r>s} (k_r - k_s) \\
 &= (k_2 - k_1)(k_3 - k_1)(k_3 - k_2) \dots (k_n - k_1) \dots (k_n - k_{n-1})
 \end{aligned}$$

This is a *Vandermonde* determinant; it is equal to the product of all possible differences of pairs of different values of  $k$  and so it is not equal to 0 (*Collatz, 1986*). Hence the  $y$  are linearly independent. The general solution of (2.9) therefore reads:

$$y = C_1 e^{k_1 x} + C_2 e^{k_2 x} + \dots + C_n e^{k_n x}$$

with the  $C_v$  as free coefficients.

**Example 2.5** For the differential equation

$$y'' + y = 0 \quad (2.11)$$

the characteristic equation is

$$k^2 + 1 = 0$$

has the roots

$$k_{1,2} = \pm i.$$

Hence the general solution is, first of all,

$$y = C_1 e^{ix} + C_2 e^{-ix}.$$

Here complex solutions of the form  $y(x) = u(x) + iv(x)$  appear. If a linear homogeneous differential equation  $L[y] = 0$  with real coefficients has such a complex-valued solution, then the real part  $u(x)$  and the imaginary part  $v(x)$  separately are each likewise solutions of the differential equation because

$$L[y] = L[u + iv] = L[u] + iL[v] = 0 .$$

and so  $L[u] = L[v] = 0$ . Further,  $Cy(x)$ , where  $C$  is an arbitrary complex constant  $C = A + iB$ , is also a solution of the differential equation, for in

$$Cy = (A + iB)(u + iv) = Au + iAv + iBu - Bv$$

each one separately of the four terms on the right satisfies the differential equation.

Now in (2.10), since the given coefficients  $p_v$  were assumed to be real, any complex roots occur, not singly, but always in pairs of *complex conjugates*, of the form

$$k_1 = a + ib, \quad k_2 = a - ib .$$

This is shown in the example above. The general solution is

$$y = C_1 e^{(a+ib)x} + C_2 e^{(a-ib)x} + \dots \quad \text{or} \quad y = C_1 e^{ax} e^{ibx} + C_2 e^{ax} e^{-ibx} + \dots .$$

Using the Euler formula

$$e^{\pm iz} = \cos z \pm i \sin z$$

we find that

$$y = e^{nx} \{ (C_1 + C_2) \cos bx + (C_1 i - C_2 i) \sin bx \} + \dots$$

$C_1$  and  $C_2$  may be arbitrary complex constants; with new constants

$$C_1 + C_2 = C_1^* \quad \text{and} \quad C_1 i - C_2 i = C_2^*$$

we obtain

$$y = e^{ax}(C_1^* \cos bx + C_2^* \sin bx) + \dots$$

Here  $C_1^*, C_2^*$  may be complex; but if we are interested in solutions in real form, we can pick out the real part from this last expression, i.e.,  $C_1^*$  and  $C_2^*$  will then be regarded as real constants. The linear independence of  $e^{ax} \cos bx$  and  $e^{ax} \sin bx$  can be shown immediately by means of the Wronskian.

In the initial equation (2.11) we then arrive at the previously known solution

$$y = C_1^* \cos x + C_2^* \sin x \text{ (Collatz, 1986).}$$

#### 2.2.4.2 Multiple Zeros of The Characteristic Equation

It can also happen that the algebraic equation (2.10) has a multiple zero; thus, at a double root, say,

$$k_1 = k_2, k_1 \neq k_m \text{ for } m = 3, \dots, n.$$

Since in this case the particular solutions

$$y_1 = e^{k_1 x} \text{ and } y_2 = e^{k_2 x}$$

are the same, the fundamental system lacks one solution. If all the  $n$  roots are equal,

$$k_1 = k_2 = \dots = k_n,$$

then  $n - 1$  particular solutions are missing. In general, let  $k_1$  be an  $r$ -fold root of (2.10) and let  $y_1(x) = e^{k_1 x}$ . The 'missing' functions for a fundamental system can be determined by applying the substitution below used for reducing the order of a linear differential equation

$$y(x) = y_1(x)z(x) \text{ (Collatz, 1986).}$$

Hence,

$$y = e^{k_1 x} z \quad \cdot p_0$$

$$y' = e^{k_1 x} (k_1 z + z') \quad \cdot p_1$$

$$y'' = e^{k_1 x} (k_1^2 z + 2k_1 z' + z'') \quad \cdot p_2$$

.....

$$y^{(n)} = e^{k_1 x} \left[ k_1^n z + \binom{n}{1} k_1^{n-1} z' + \dots + z^{(n)} \right] \quad \cdot p_n$$

The coefficients appearing in the square brackets are binomial coefficients. We multiply by  $p_0, p_1, \dots, p_n$  as indicated, and add. In (2.9), then, with  $L[Y] = L[y_1 z]$  we obtain the following expression, multiplied by the common factor  $e^{k_1 x}$ :

$$\begin{aligned} & \underbrace{z(p_0 + p_1 k_1 + p_2 k_1^2 + \dots + p_n k_1^n)}_{\text{(I)}} \\ & + \underbrace{z' \left( p_1 + \binom{2}{1} p_2 k_1 + \binom{3}{1} p_3 k_1^2 + \dots + \binom{n}{1} p_n k_1^{n-1} \right)}_{\text{(II)}} \\ & + \underbrace{z'' \left( p_2 + \binom{3}{2} p_3 k_1 + \binom{4}{2} p_4 k_1^2 + \dots + \binom{n}{2} p_n k_1^{n-2} \right)}_{\text{(III)}} + \dots + \underbrace{z^{(n)}(p_n)}_{\text{(N+1)}}. \end{aligned}$$

The bracket marked (I) is the characteristic polynomial  $P(k)$  once more of (2.10) at the point  $k = k_1$ ; the brackets marked (II) is the first derivative of  $P(k)$  with respect to  $k$  at the point  $k = k_1$ ; the bracket (III) is its second derivative, divided by  $2!$ , and so on up to the bracket marked  $(N + 1)$ , the  $n^{\text{th}}$  derivative of  $P(k)$  divided by  $n!$ :

$$L[e^{k_1 x} z] = e^{k_1 x} \left\{ zP(k_1) + \frac{z'}{1!} \frac{dP(k_1)}{dk} + \frac{z''}{2!} \frac{d^2 P(k_1)}{dk^2} + \dots + \frac{z^{(n)}}{n!} \frac{d^n P(k_1)}{dk^n} \right\}.$$

If  $k_1$  is a simple zero of  $P(k)$ , the bracket (II) is equal to 0; if  $k_1$  is a double zero, then the first derivative of  $P(k)$  also vanishes at  $k_1$ . In general, for an  $r$ -fold zero  $k_1$ , the derivatives up to and including the  $(r - 1)^{\text{th}}$  order all vanish at  $k_1$ :

$$P(k) = \frac{dP(k_1)}{dk} = \frac{d^2P(k_1)}{dk^2} = \dots = \frac{d^{r-1}P(k_1)}{dk^{r-1}} = 0.$$

The differential equation for  $z$  therefore begins with the  $r^{\text{th}}$  derivative and has the form

$$q_r z^{(r)} + \dots + q_n z^{(n)} = 0.$$

Hence any polynomial of at most the  $(r - 1)^{\text{th}}$  degree is a solution of the differential equation for  $z$ :

$$z = C_1 + C_2 x + \dots + C_r x^{r-1},$$

and so the original differential equation (2.9) has the solution

$$y = e^{k_1 x} z = e^{k_1 x} (C_1 + C_2 x + \dots + C_r x^{r-1}).$$

In general, if the characteristic polynomial (2.10) has the zeros  $k_1, \dots, k_s$  distinct from one another and of multiplicities  $r_1, \dots, r_s$  respectively with  $r_1, \dots, r_s = n$ , then the differential equation (2.9) has the  $n$  solutions

$$e^{k_1 x}, \quad x e^{k_1 x}, \dots, \quad x^{r_1-1} e^{k_1 x}, \dots, e^{k_s x}, \quad x e^{k_s x}, \dots, x^{r_s-1} e^{k_s x} \quad (2.12).$$

If, for example, there are two double zeros  $k_1 = k_2, k_3 = k_4$ , then correspondingly the differential equation (2.9) has the solution

$$y = e^{k_1 x} (C_1 + C_2 x) + e^{k_3 x} (C_3 + C_4 x) + C_5 e^{k_5 x} + \dots + C_n e^{k_n x}.$$

We have still to show, however, that the newly adopted solutions of the form  $x^s e^{kx}$  really do serve to complete the fundamental system as required, i.e., that the functions (2.12) are linearly independent of one another, so that no non-trivial combination of them can vanish identically. We show, more generally, that a relation

$$\sum_{j=1}^s P_j(x) e^{k_j x} \equiv 0 \quad (2.13),$$



where the  $P_j(x)$  are polynomials, can hold only if all the polynomials  $P_j(x)$  are identically zero. For if there were such a relation (2.13) in which not all the  $P_j$  vanish, we could assume, e.g., that  $P_1$ , say, is not identically zero. Division of (2.13) by  $e^{k_s x}$ , gives

$$\sum_{j=1}^{s-1} P_j(x) e^{(k_j - k_s)x} + P_s(x) \equiv 0 \quad (2.14).$$

Let  $P_j$  have degree  $g_j$ ; we then differentiate (2.14)  $(g_j + 1)$  times with respect to  $x$ . As a result,  $P_s(x)$  disappears. A term  $P_j(x)e^{\alpha x}$  gives on differentiation a term  $Q_j(x)e^{\alpha x}$ , where  $Q_j(x)$  is again a polynomial, which, if  $\alpha \neq 0$ , is of the same degree as  $P_j(x)$ . Since  $k_j \neq k_s$  for  $j \neq s$ , the condition  $\alpha \neq 0$  here is always fulfilled. After differentiating  $(g_s + 1)$  times an equation of the form

$$\sum_{j=1}^{s-1} P_j^*(x) e^{(k_j - k_s)x} \equiv 0 \quad (2.15)$$

arises, and the degree of  $P_j^* = \text{degree of } P_j$ .

This process is continued; we divide this equation by

$$e^{(k_{s-1} - k_s)x}$$

and differentiate  $(g_{s-1} + 1)$  times; so then  $P_{s-1}^*$  also disappears and we obtain an equation of the form (2.15), where now the summation is only from  $j = 1$  to  $j = s - 2$  and new polynomials appear as factors but these always have the same degree because the exponential functions have the form  $e^{\alpha x}$  with  $\alpha \neq 0$  ( $\alpha$  is always the difference of two  $k_p$ -values). On continuing the process we finally arrive at an equation

$$\tilde{P}_1(x) e^{(k_1 - k_2)x} \equiv 0,$$

where  $\tilde{P}_1(x)$  has the same degree as  $P_1(x)$  and so cannot be identically zero. We have a contradiction, and therefore the functions (2.12) are indeed linearly independent (Collatz, 1986).

## 2.2.5 Nonhomogeneous Equations Theory

The cases mostly discussed in chapter 4 are ‘perturbing function’. So, nonhomogeneous equations are important for this study. In order to take into consideration the effect of the excitation  $P(t) = m\ddot{x} + k\dot{x} + cx$  (Here  $m$  is vibrating mass,  $k$  the damping constant, and  $c$  the specific restoring force (Collatz,1986).), we need, in accordance with the superposition principle, a particular solutions of the nonhomogeneous differential equation. They are known as the method of undetermined coefficients and the method of variation of parameters, respectively.

### 2.2.5.1 Method of Undetermined Coefficients

We now look at the nonhomogeneous equation

$$L[y] = y'' + p(t)y' + q(t)y = g(t) \quad (2.16),$$

where  $p$ ,  $q$ , and  $g$  are given (continuous) functions on the open interval  $I$ . The equation

$$L[y] = y'' + p(t)y' + q(t)y = 0 \quad (2.17),$$

in which  $g(t) = 0$  and  $p$  and  $q$  are the same as in Eq. (2.16), is called the homogeneous equation corresponding to Eq. (2.17). The following two results describe the structure of solutions of the nonhomogeneous equation (2.16) and provide a basis for constructing its general solution (Boyce and Diprima,2001).

**Theorem 2.3** If  $Y_1$  and  $Y_2$  are two solutions of the nonhomogeneous equation (2.16), then their difference  $Y_1 - Y_2$  is a solution of the corresponding homogeneous equation (2.17). If, in addition,  $y_1$  and  $y_2$  are a fundamental set of solutions of Eq. (2.17), then

$$Y_1(t) - Y_2(t) = c_1y_1(t) + c_2y_2(t) \quad (2.18),$$

where  $c_1$  and  $c_2$  are certain constants (Boyce and Diprima,2001).

To prove this result, note that  $Y_1$  and  $Y_2$  satisfy the equations

$$L[Y_1](t) = g(t), \quad L[Y_2](t) = g(t).$$

Subtracting the second of these equations from the first, we have

$$L[Y_1](t) - L[Y_2](t) = g(t) - g(t) = 0 \quad (2.19).$$

However,

$$L[Y_1] - L[Y_2] = L[Y_1 - Y_2],$$

so Eq. (2.19) becomes

$$L[Y_1 - Y_2](t) = 0 \quad (2.20).$$

Equation (2.20) states that  $Y_1 - Y_2$  is a solution of Eq. (2.17). Finally, according to Boyce and Diprima (2001)  $Y_1 - Y_2$  can be so written. Hence Eq. (2.18) holds and the proof is complete.

#### **Theorem 2.4**

The general solution of the nonhomogeneous equation (2.16) can be written in the form

$$y = \phi(t) = c_1 y_1(t) + c_2 y_2(t) + Y(t) \quad (2.21),$$

where  $y_1$  and  $y_2$  are a fundamental set of solutions of the corresponding homogeneous equation (2.17),  $c_1$  and  $c_2$  are arbitrary constants, and  $Y$  is some specific solution of the nonhomogeneous equation (2.16) (Boyce and Diprima, 2001).

The proof of Theorem above follows quickly from the preceding theorem. Note that Eq. (2.20) holds if we identify  $Y_1$  with an arbitrary solution  $\phi$  of Eq. (2.16) and  $Y_2$  with the specific solution  $Y$ . From Eq. (2.20) we thereby obtain

$$\varphi(t) - Y(t) = c_1 y_1(t) + c_2 y_2(t),$$

which is equivalent to Eq. (2.23). Since  $\varphi$  is an arbitrary solution of Eq. (2.16), the expression on the right side of Eq. (2.21) includes all solutions of Eq. (2.16); thus it is natural to call it the general solution of Eq. (2.16).

In somewhat different words, Theorem above states that to solve the nonhomogeneous equation (2.16), we must do three things;

Firstly, find the general solution  $c_1 y_1(t) + c_2 y_2(t)$  of the corresponding homogeneous equation. This solution is frequently called the *complementary solution* and may be denoted by  $y_c(t)$ . In second, find some single solution  $Y(t)$  of the nonhomogeneous equation. Often this solution is referred to as a particular solution. And lastly add together the functions found in the two preceding steps (Boyce and Diprima,2001). Now method of undetermined coefficients is going to be illustrated by simple examples.

**Example 2.6** Find a particular solution of

$$y'' - 3y' - 4y = 3e^{2t}. \quad (1)$$

*Solution* We seek a function  $Y$  such that the combination  $Y''(t) - 3Y'(t) - 4Y(t)$  is equal to  $3e^{2t}$ . Since the exponential function reproduces itself through differentiation, the most plausible way to achieve the desired result is to assume that  $Y(t)$  is some multiple of  $e^{2t}$ , that is,

$$Y(t) = Ae^{2t},$$

where the coefficient  $A$  is yet to be determined. To find  $A$  we calculate

$$Y' = 2Ae^{2t}, \quad Y''(t) = 4Ae^{2t},$$

and substitute for  $y, y'$ , and  $y''$  in Equation (1). We obtain

$$(4A - 6A - 4A)e^{2t} = 3e^{2t}.$$

Hence  $-6Ae^{2t}$  must equal  $3e^{2t}$ , so  $A = -1/2$ . Thus a particular solution is

$$Y(t) = -\frac{1}{2}e^{2t} \quad (\text{Boyce and Diprima,2001}).$$

It has been discussed that how to find  $y_c(t)$ , at least when the homogeneous equation (2.19) has constant coefficients. Therefore, in the remainder of this section and in the next, we will focus on finding a particular solution  $Y(t)$  of the nonhomogeneous equation (2.16). There are two methods that is wished to discuss. They are known as the method of undetermined coefficients and the method of variation of parameters, respectively.

If the general solution of the homogeneous differential equation is known, we can use the method of variation of the constants, as described in Chapter 2.2.5.2, to carry out which, certain quadratures are necessary. So if a fundamental system of the homogeneous equation is available, we can always force out the solution of the nonhomogeneous equation by quadratures (Collatz,1986).

### 2.2.5.2 The Method of Variation of The Constants

In this section we describe another method of finding a particular solution of a nonhomogeneous equation. This method, known as variation of constants (parameters), is due to Lagrange and complements the method of undetermined coefficients rather well. The main advantage of variation of constants is that it is a general method; in principle at least, it can be applied to any equation, and it requires no detailed assumptions about the form of the solution. In fact, later in this section we use this method to derive a formula for a particular solution of an arbitrary second order linear nonhomogeneous differential equation. On the other hand, the method of variation of constants eventually requires that we evaluate certain integrals involving the nonhomogeneous term in the differential equation, and this may present difficulties (Boyce and Diprima, 2001). It is going to be looked at this method now.

This is a generalization of the method described in Chapter 2.2.2 for first-order equations. In the linear differential equation

$$L[y] = \sum_{v=0}^n p_v(x)y^{(v)}(x) = r(x)$$

suppose a fundamental system  $y_1, y_2, \dots, y_n$  is known for the homogeneous equation. Its general solution is therefore

$$y = C_1y_1 + C_2y_2 + \dots + C_ny_n \text{ (Collatz, 1986).}$$

As before in Chapter 2.2.2 here too the constants  $C_\mu$  are replaced by functions  $C_\mu(x)$  which are to be determined, and so for a particular solution  $u(x)$  of the nonhomogeneous equation we make the substitution

$$u = C_1(x)y_1 + C_2(x)y_2 + \dots + C_n(x)y_n .$$

By so doing we are really over-determining the solution substitution, since we actually need not  $n$  unknown functions  $C_\mu(x)$  but only one solution function. We can therefore prescribe a further  $n - 1$  conditions, and we choose them so that certain expressions which appear when the derivatives  $u, u', \dots, u^{(n)}$  are formed shall vanish, and the substitution of  $u, u', \dots, u^{(n)}$  into the differential equation will then give a simple result. Thus we demand, for example, in forming the derivative

$$u' = C_1y_1' + \dots + C_ny_n' + C_1'y_1 + \dots + C_n'y_n$$

that the second part  $C_1'y_1 + \dots + C_n'y_n$  shall vanish. There then remains simply

$$u' = C_1y_1' + \dots + C_ny_n' ,$$

and the next differentiation can easily be carried out. Proceeding in the same way with the successive derivatives we require that generally

$$C_1'y_1^{(v)} + \dots + C_n'y_n^{(v)} = 0 \quad \text{for } v = 0, 1, \dots, n - 2 \quad (2.22).$$

We then have

$$u^{(v)} = C_1y_1^{(v)} + \dots + C_ny_n^{(v)} , \quad v = 0, 1, \dots, n - 1,$$

$$u^{(n)} = C_1 y_1^{(n)} + \cdots + C_n y_n^{(n)} + C_1' y_1^{(n-1)} + \cdots + C_n' y_n^{(n-1)} .$$

Substituting all these derivatives into the nonhomogeneous differential equation we obtain

$$L[u] = C_1 \underbrace{L[y_1]}_{=0} + C_2 \underbrace{L[y_2]}_{=0} + \cdots + C_n \underbrace{L[y_n]}_{=0} + \sum_{\mu=1}^n C_\mu' y_\mu^{(n-1)} p_n(x) = r(x);$$

since the  $y_\mu$  are particular solutions.

Hence, we have the further condition for the  $C_\mu'$ :

$$C_1' y_1^{(n-1)} + \cdots + C_n' y_n^{(n-1)} = \frac{r(x)}{p_n(x)} \quad (2.23).$$

Eq. (2.22) and eq. (2.23) together form a system of  $n$  equations for the  $n$  unknowns  $C_\mu'(x)$  (Collatz, 1986).

But the determinant of the coefficients of these equations is just the Wronskian (2.6) of the fundamental system  $y_\nu$  and it is therefore non-zero. Hence the equations are uniquely soluble and enable  $C_1'(x), C_2'(x), \dots, C_n'(x)$  to be calculated; these functions are therefore continuous and consequently integrable. On integration we hence obtain the functions

$$C_\mu(x) = \int_{x_0}^x C_\mu'(x) dx + C_\mu^*, \quad (\mu = 1, 2, \dots, n).$$

By including the integration constants  $C_\mu^*$  we obtain after substitution the general solution of the complete differential equation (Collatz, 1986).

**Example 2.7** Find a particular solution of

$$y'' + 4y = 3 \csc t . \quad (1)$$

*Solution* Observe that this problem does not fall within the scope of the method of undetermined coefficients because the nonhomogeneous term  $g(t) = 3 \csc t$  involves

a quotient (rather than a sum or a product) of  $\sin t$  or  $\cos t$ . Therefore, we need a different approach. Observe also that the homogeneous equation corresponding to Eq. (1) is

$$y'' + 4y = 0, \quad (2)$$

and that the general solution of Eq. (2) is

$$y_c(t) = c_1 \cos 2t + c_2 \sin 2t. \quad (3)$$

The basic idea in the method of variation of parameters is to replace the constants  $c_1$  and  $c_2$  in Eq. (3) by functions  $u_1(t)$  and  $u_2(t)$ , respectively, and then to determine these functions so that the resulting expression

$$y = u_1(t) \cos 2t + u_2(t) \sin 2t \quad (4)$$

is a solution of the nonhomogeneous equation (1).

To determine  $u_1$  and  $u_2$  we need to substitute for  $y$  from Eq. (4) in Eq. (1). However, even without carrying out this substitution, we can anticipate that the result will be a single equation involving some combination of  $u_1$ ,  $u_2$ , and their first two derivatives. Since there is only one equation and two unknown functions, we can expect that there are many possible choices of  $u_1$  and  $u_2$  that will meet our needs. Alternatively, we may be able to impose a second condition of our own choosing, thereby obtaining two equations for the two unknown functions  $u_1$  and  $u_2$ . We will soon show (following Lagrange) that it is possible to choose this second condition in a way that makes the computation markedly more efficient.

Returning now to Eq. (4), we differentiate it and rearrange the terms, thereby obtaining

$$y' = -2u_1(t) \sin 2t + 2u_2(t) \cos 2t + u_1'(t) \cos 2t + u_2'(t) \sin 2t. \quad (5)$$

Keeping in mind the possibility of choosing a second condition on  $u_1$  and  $u_2$ , let us require the last two terms on the right side of Eq. (5) to be zero; that is, we require that



$$u_1'(t) \cos 2t + u_2'(t) \sin 2t = 0. \quad (6)$$

It then follows from Eq. (5) that

$$y' = -2u_1(t) \sin 2t + 2u_2(t) \cos 2t. \quad (7)$$

Although the ultimate effect of the condition (6) is not yet clear, at the very least it has simplified the expression for  $y^1$ . Further, by differentiating Eq. (7), we obtain

$$y'' = -4u_1(t) \cos 2t - 4u_2(t) \sin 2t - 2u_1'(t) \sin 2t + 2u_2'(t) \cos 2t. \quad (8)$$

Then, substituting for  $y$  and  $y''$  in Eq. (1) from Eqs. (4) and (8), respectively, we find that  $u_1$  and  $u_2$  must satisfy

$$-2u_1'(t) \sin 2t + 2u_2'(t) \cos 2t = 3 \csc t. \quad (9)$$

Summarizing our results to this point, we want to choose  $u_1$  and  $u_2$  so as to satisfy Eqs. (6) and (9). These equations can be viewed as a pair of linear algebraic equations for the two unknown quantities  $u_1'(t)$  and  $u_2'(t)$ . Equations (6) and (9) can be solved in various ways. For example, solving Eq. (6) for  $u_2'(t)$ , we have

$$u_2'(t) = -u_1'(t) \frac{\cos 2t}{\sin 2t}. \quad (10)$$

Then, substituting for  $u_2'(t)$  in Eq. (9) and simplifying, we obtain

$$u_1'(t) = -\frac{3 \csc t \sin 2t}{2} = -3 \cos t. \quad (11)$$

Further, putting this expression for  $u_1'(t)$  back in Eq. (10) and using the double angle formulas, we find that

$$u_2'(t) = \frac{3 \cos t \cos 2t}{\sin 2t} = \frac{3(1 - 2 \sin^2 t)}{2 \sin t} = \frac{3}{2} \csc t - 3 \sin t. \quad (12)$$

Having obtained  $u_1'(t)$  and  $u_2'(t)$ , the next step is to integrate so as to obtain  $u_1(t)$  and  $u_2(t)$ . The result is

$$u_1(t) = -3 \sin t + c_1 \quad (13)$$

and

$$u_2(t) = \frac{3}{2} \ln |\csc t - \cot t| + 3 \cos t + c_2. \quad (14)$$

Finally, on substituting these expressions in Eq. (4), we have

$$y = -3 \sin t \cos 2t + \frac{3}{2} \ln |\csc t - \cot t| \sin 2t + 3 \cos t \sin 2t + c_1 \cos 2t + c_2 \sin 2t,$$

Or

$$y = 3 \sin t + \frac{3}{2} \ln |\csc t - \cot t| \sin 2t + c_1 \cos 2t + c_2 \sin 2t. \quad (15)$$

The terms in Eq. (15) involving the arbitrary constants  $c_1$  and  $c_2$  are the general solution of the corresponding homogeneous equation, while the remaining terms are a particular solution of the nonhomogeneous equation (1). Therefore Eq. (15) is the general solution of Eq. (1) (Boyce and DiPrima, 2001).

In the preceding example the method of variation of parameters worked well in determining a particular solution, and hence the general solution, of Eq. (1). Now a different method is going to be discussed.

### 2.2.6 Euler Equations

A further type of integrable linear differential equations, with non-constant coefficients, is the *Euler* differential equation

$$p_0 y + p_1 x y' + p_2 x^2 y'' + \dots p_n x^n y^{(n)} = r(x).$$

The  $p_v$  are given constants with  $p_n \neq 0$  (Collatz,1986).

It suffices to discuss the homogeneous equation

$$\sum_{v=0}^n p_v x^v y^{(v)} = 0, \quad (2.24)$$

The obvious substitution

$$y = x^r, \quad y' = r x^{r-1}, \quad y'' = r(r-1)x^{r-2}, \dots,$$

$$y^{(n)} = r(r-1)(r-2) \dots (r-n+1)x^{r-n}$$

leads, after dividing through by  $x^r$ , to the characteristic equation

$$p_0 + p_1 r + p_2 r(r-1) + \dots + p_n r(r-1)(r-2) \dots (r-n+1) = 0. \quad (2.25)$$

This is an algebraic equation of the  $n^{\text{th}}$  degree; let the roots be

$$r_1, r_2, r_3, \dots, r_n.$$

If all the roots are distinct, then the general solution of the differential equation reads

$$y = C_1 x^{r_1} + C_2 x^{r_2} + \dots + C_n x^{r_n}.$$

It now has to be shown that the powers  $x^{r_1}, \dots, x^{r_n}$  actually are linearly independent. However, it is possible to get rid of the trouble of proving this (not difficult), and of investigating what happens when the characteristic equation has multiple roots, if the differential equation (2.24) reduced to a linear equation with constant coefficients, for which the circumstances have already been completely discussed in Chapter 2.1.2. This reduction is performed by the transformation, for  $x > 0$  (for  $x < 0$  replace  $x$  by  $-x$ )

$$z = \ln x, x = e^z, \quad \frac{dy}{dz} = Dx = x,$$

where the symbol  $D$  has been introduced to denote differentiation with respect to  $z$ . So then

$$Dy = \frac{dy}{dz} = \frac{dy}{dx} \frac{dx}{dz} = xy'$$

$$D^2y = D(xy') = xy' + xy'' \cdot x$$

Or

$$x^2y'' = D^2y - xy' = D^2y - Dy = D(D - 1)y.$$

In general, for the  $q^{\text{th}}$  derivative we have

$$x^qy^{(q)} = D(D - 1) \dots (D - q + 1)y.$$

This rule can be proved immediately by induction; the step from  $q$  to  $q + 1$  is obtained by multiplying by  $D - q$ :

$$\begin{aligned} (D - q)x^qy^{(q)} &= D(x^qy^{(q)}) - qx^qy^{(q)} = qx^qy^{(q)} + x^qy^{(q+1)} \cdot x - qx^qy^{(q)} \\ &= x^{q+1}y^{(q+1)}. \end{aligned}$$

On the other hand,

$$(D - q)x^qy^{(q)} = D(D - 1) \dots (D - q)y.$$

The transformation thus gives the new differential equation with constant coefficients for the function  $v(z) = y(e^z)$

$$\sum_{v=0}^n p_v D(D - 1) \dots (D - v + 1)v = 0.$$

The characteristic equation (2.10) for this is identical with the characteristic equation (2.25), but now the results of the theory in Chapter 2.1.2 are available: if all

the roots  $r_1, \dots, r_n$  are distinct, then  $x^{r_1}, \dots, x^{r_n}$  form a fundamental system; if  $r_1$  is a  $p$ -fold root, then

$$e^{r_1 z}, \quad ze^{r_1 z}, \dots, z^{p-1}e^{r_1 z}$$

or, transformed,

$$x^{r_1}, \quad (\ln x)x^{r_1}, \dots, (\ln x)^{p-1}x^{r_1}$$

are solutions of (2.24) (Collatz, 1986).

Now some examples of Euler equations are given for three circumstances. Firstly, solution with distinct roots is given. Second example is with complex roots and the third example is for states when the roots are equal.

**Example 2.8** Find the general solution of the equation below;

$$x^3 y''' - 3x^2 y'' + 6xy' - 6y = 0.$$

*Solution*      The substitution

$$y = x^r$$

leads to

$$r^3 - 6r^2 + 11r - 6 = 0$$

with the roots  $r_1 = 1, r_2 = 2, r_3 = 3$ . The general solution is therefore

$$y = C_1 x + C_2 x^2 + C_3 x^3 \text{ (Collatz, 1986).}$$

**Example 2.9** If conjugate complex roots occur

$$r_1 = a + ib, \quad r_2 = a - ib,$$

one converts the particular solutions

$$x^{r_1} = x^{a+ib} = x^a x^{ib}, \quad x^{r_2} = x^{a-ib} = x^a x^{-ib}$$

by Euler's formula (see Chapter 2.2.4.1) into

$$x^{\pm ib} = e^{\pm(\ln x)ib} = \cos(b \ln x) \pm i \sin(b \ln x).$$

Then, with  $C_1^* = C_1 + C_2$  and  $C_2^* = iC_1 - iC_2$  the solution is obtained as

$$y = x^a [C_1^* \cos(b \ln x) + C_2^* \sin(b \ln x)] + \dots.$$

For example, for

$$x^2 y'' - xy' + 2y = 0$$

the substitution  $y = x^r$  leads to  $r^2 - 2r + 2 = 0$ , and so  $r_{1,2} = 1 \pm i$ .

From

$$y = c_1 x^{1+i} + c_2 x^{1-i}$$

we get the general solution in real form

$$y = x [C_1^* \cos(\ln x) + C_2^* \sin(\ln x)]. \text{ (Collatz, 1986)}$$

**Example 2.10** The substitution  $y = x^r$  leads to  $r^2 + 2r + 1 = (r + 1)^2 = 0$ , therefore  $r_1 = r_2 = -1$ . There are equal roots. Therefore the general solution reads

$$y(x) = \frac{C_1}{x} + C_2 \frac{\ln x}{x}$$

(Collatz, 1986).

## 2.3 Linear Differential Equation Systems

In applications, systems of linear ordinary differential equations are often encountered. Even in those cases where it is possible by eliminating some of the

unknowns to convert such a system into a single equivalent differential equation of higher order, it is often more sensible to attack the system of equations directly. Therefore some of the properties of such systems are presented here briefly.

Consider a linear system of  $n$  first-order differential equations for  $n$  unknown functions  $y_1(x), \dots, y_n(x)$ :

$$y'_j(x) = \sum_{k=1}^n a_{jk}(x)y_k(x) + r_j(x), \quad (j = 1, \dots, n). \quad (2.26)$$

The  $a_{jk}(x)$  and  $r(x)$  are continuous functions defined in an interval  $a \leq x \leq b$ ; if the  $r_j(x) \equiv 0$  in  $(a, b)$ , then the system is said to be *homogeneous*, otherwise it is *nonhomogeneous* (Collatz, 1986).

With the matrix notation

$$y(x) = \begin{pmatrix} y_1(x) \\ \cdot \\ y_n(x) \end{pmatrix}, \quad r(x) = \begin{pmatrix} r_1(x) \\ \cdot \\ r_n(x) \end{pmatrix}, \quad A(x) = \begin{pmatrix} a_{11}(x) & \dots & a_{1n}(x) \\ \dots & \dots & \dots \\ a_{n1}(x) & \dots & a_{nn}(x) \end{pmatrix}$$

the system (2.26) is written more shortly as

$$y'(x) = A(x)y(x) + r(x). \quad (2.27)$$

By the general existence and uniqueness theorem in Chapter 2.2.7, when the initial values  $y(x_0)$  at a point  $x = x_0$  in  $(a, b)$  are prescribed, there is one and only one solution of (2.27) which assumes these initial values (for brevity it is said to be 'solution' instead of 'system of solutions'). First a homogeneous system with  $r(x) \equiv 0$  is considered, and several, say  $n$ , different solutions

$$y_{(1)}, y_{(2)}, \dots, y_{(n)}.$$

Each of these solutions has  $n$  components,  $y_{(j)} = \begin{pmatrix} y_{1j} \\ \cdot \\ \cdot \\ \cdot \\ y_{nj} \end{pmatrix}$ .

By writing these column-vectors one beside another, matrix  $T$  is obtained.

$$Y(x) = (y_{(1)}(x), \dots, y_{(n)}(x)) = \begin{pmatrix} y_{11}(x) & \dots & y_{1n}(x) \\ \dots & \dots & \dots \\ y_{n1}(x) & \dots & y_{nn}(x) \end{pmatrix}.$$

Since each column is a solution

$$Y'(x) = A(x).Y(x). \quad (2.28)$$

also holds (Collatz,1986).

**Definition 2.1 :**

The solutions  $y_{(j)}$  are said to form a *fundamental system or principal system* if the determinant  $D$  of  $Y(x)$  for any  $x_0$  in  $(a, b)$  does not vanish:

$$D(x_0) = \det Y(x_0) \neq 0.$$

If now  $C = (c_{jk})$  is a non-singular matrix (i.e, a matrix with a non-vanishing determinant,  $\det C \neq 0$ ) whose elements  $c_{jk}$  are constant numbers, then if  $Y$  is a matrix whose columns are solutions, so also is  $Y(x)C$ , because solution can be superimposed and multiplied by constant factors, and so the columns of  $Y(x)C$  are still solutions. If  $Y$  is a fundamental system, then so is  $YC$ , since

$$\det(Y(x_0)C) = \det Y(x_0) \det C \neq 0.$$

Now  $D(x)$ , exactly like the Wronskian in Chapter 2.2.2 satisfies a homogeneous, linear, first-order differential equation. For, regarding  $D$  as a function of its elements  $y_{jk}$ , we have



$$D'(x) = \frac{dD(x)}{dx} = \sum_{j,k=1}^n \frac{\partial D(x)}{\partial y_{jk}} \frac{dy_{jk}}{dx} \quad (\text{Collatz, 1986})$$

$\partial y/\partial x$  is the minor  $Y_{jk}$  of the element  $y_{jk}$  in  $D$ , and, from (2.28),

$$\frac{dy_{jk}}{dx} = \sum_{i=1}^n a_{ji} y_{ik}.$$

So, using the Kronecker symbol

$$\delta_{jl} \begin{cases} 0 & \text{for } j \neq l \\ 1 & \text{for } j = l \end{cases}$$

we have

$$D'(x) = \sum_{j,l=1}^n a_{jl} \sum_{k=1}^n Y_{jk} y_{lk} = \sum_{j,l=1}^n a_{jl} \delta_{jl} D;$$

since the inner sum, by the rules for expanding determinants by rows, represents  $D$  itself when  $j = l$  and vanishes for  $j \neq l$ ; so there remain from the summation only the terms with  $j = l$ :

$$D'(x) = S_A(x) \cdot D(x) \quad \text{where } S_A(x) = \sum_{j=1}^n a_{jj}(x).$$

$S_A$  is the sum of the elements in the principal diagonal, i.e., it is the trace of the matrix  $A$  (Collatz, 1986).

As in (2.8) it follows that

$$D(x) = D(x_0) \cdot \exp\left(\int_{x_0}^x S_A(t) dt\right).$$

This form includes (2.8) as a special case. As before, it is also the case here that:

$D(x_0) \neq 0$  implies that  $D(x)$  does not vanish anywhere in  $(a, b)$ ;

$D(x_0) = 0$  implies that  $D(x)$  vanishes identically in  $(a, b)$  (Collatz, 1986).

### 2.3.1 Elimination Method

The most elementary approach to linear systems of differential equations involves the elimination of dependent variables by appropriately combining pairs of equations. The object of this procedure is to eliminate dependent variables in succession until there remains only a single equation containing only one dependent variable. This remaining equation will usually be a linear equation of high order and can frequently be solved by the methods of Chapter 2.2. After its solution has been found, the other dependent variables can be found in turn, using either the original differential equations or those that have appeared in the elimination process (Edwards and Penney, 1996).

The *method of elimination* for linear differential systems is similar to the solution of a linear system of algebraic equations by a process of eliminating the unknowns one at a time until only a single equation with a single unknown remains. It is most convenient in the case of manageably small systems: those containing no more than two or three equations. For such systems the method of elimination provides a simple and concrete approach that requires little preliminary theory or formal machinery. But for larger systems of differential equations, as well as for theoretical discussion, the matrix methods are preferable. However, since matrix methods are not examined in this project matrix methods are not given in this project (Edwards and Penney, 1996).

**Example 2.11** Find the particular solution of the system

$$x' = 4x - 3y, \quad y' = 6x - 7y \quad (1)$$

that satisfies the initial conditions  $x(0) = 2, y(0) = -1$ .

*Solution:* If we solve the second equation in (1) for  $x$ , we get

$$x = \frac{1}{6}y' + \frac{7}{6}y, \quad (2)$$

so that

$$x' = \frac{1}{6}y'' + \frac{7}{6}y'. \quad (3)$$

Then these expressions are substituted for  $x$  and  $x'$  in the first equation of the system in (1) ; this yields

$$\frac{1}{6}y'' + \frac{7}{6}y' = 4\left(\frac{1}{6}y' + \frac{7}{6}y\right) - 3y,$$

which is simplified to

$$y'' + 3y' - 10y = 0.$$

This second-order linear equation has characteristic equation

$$r^2 + 3r - 10 = (r - 2)(r + 5) = 0,$$

so its general solution is

$$y(t) = c_1e^{2t} + c_2e^{-5t}. \quad (4)$$

Next, substitution of (4) in (2) gives

$$x(t) = \frac{1}{6}(2c_1e^{2t} - 5c_2e^{-5t}) + \frac{7}{6}(c_1e^{2t} + c_2e^{-5t});$$

that is,

$$x(t) = \frac{3}{2}c_1e^{2t} + \frac{1}{3}c_2e^{-5t}. \quad (5)$$

Thus Eqs. (4) and (5) constitute the general solution of the system in (1).

The given initial conditions imply that

$$x(0) = \frac{3}{2}c_1 + \frac{1}{3}c_2 = 2$$

and that

$$y(0) = c_1 + c_2 = -1 ;$$

these equations are readily solved for  $c_1 = 2$  and  $c_2 = -3$ . Hence the desired solution is

$$x(t) = 3e^{2t} - e^{-5t}, \quad y(t) = 2e^{2t} - 3e^{-5t} \text{ (Edwards and Penney, 1996).}$$

Remark: The general solution defined by Eqs. (4) and (5) may be regarded as the pair or vector  $(x(t), y(t))$ . Recalling the componentwise addition of vectors (and multiplication of vectors by scalars), we can write the general solution in (4) and (5) in the form

$$\begin{aligned} (x(t), y(t)) &= \left( \frac{3}{2}c_1e^{2t} + \frac{1}{3}c_2e^{-5t}, c_1e^{2t} + c_2e^{-5t} \right) \\ &= c_1 \left( \frac{3}{2}e^{2t}, e^{2t} \right) + c_2 \left( \frac{1}{3}e^{-5t}, e^{-5t} \right) \text{ (Edwards and Penney, 1996).} \end{aligned}$$

This expression presents the general solution of the system in (1) as a linear combination of the two particular solutions

$$\begin{aligned} (x_1, y_1) &= \left( \frac{3}{2}e^{2t}, e^{2t} \right) \quad \text{and} \quad (x_2, y_2) \\ &= \left( \frac{1}{3}e^{-5t}, e^{-5t} \right) \text{ (Edwards and Penney, 1996).} \end{aligned}$$

### 2.3.2 Eigenvalue Method

Now a powerful alternative to the method of elimination for constructing the general solution of a homogeneous first-order linear system with constant coefficients is going to be introduced.

**Definition 2.2** Eigenvalues and eigenvectors:

The number  $\lambda$  (either zero or nonzero) is called an *eigenvalue* of the  $n \times n$  matrix  $A$  provided that

$$|A - \lambda I| = 0 \text{ (Edwards and Penney, 1996).}$$

An *eigenvector* associated with the eigenvalue  $\lambda$  is a nonzero vector  $v$  such that  $Av = \lambda v$ , so that

$$(A - \lambda I)v = 0 \text{ (Edwards and Penney, 1996).}$$

Note that if  $v$  is an eigenvector associated with the eigenvalue  $\lambda$ , then so is any nonzero constant scalar multiple  $cv$  of  $v$ —this follows upon multiplication of each side in Eq. (6) by  $c \neq 0$  (Edwards and Penney, 1996).

The prefix *eigen* is a German word with the approximate translation characteristic in this context; the terms characteristic value and characteristic vector are in common use. For this reason, the equation

$$|A - \lambda I| = \begin{vmatrix} a_{11} - \lambda & a_{12} & \cdots & a_{1n} \\ a_{21} & a_{22} - \lambda & \cdots & a_{2n} \\ \vdots & \vdots & \ddots & \vdots \\ a_{n1} & a_{n2} & \cdots & a_{nn} - \lambda \end{vmatrix} = 0 \text{ (2.29)}$$

is called the characteristic equation of the matrix  $A$ ; its roots are the eigenvalues of  $A$ . Upon expanding the determinant in (2.29), an  $n^{\text{th}}$ -degree polynomial of the form evidently got

$$(-1)^n \lambda^n + b_{n-1} \lambda^{n-1} + \cdots + b_1 \lambda + b_0 = 0 \text{ (Edwards and Penney, 1996).}$$

By the fundamental theorem of algebra, this equation has  $n$  roots—possibly some are complex, possibly some are repeated—and thus an  $n \times n$  matrix has  $n$  eigenvalues (counting repetitions, if any). Although we assume that the elements of  $A$  are real numbers, we allow the possibility of complex eigenvalues and complex-valued eigenvectors.

Following theorem is the basis for the eigenvalue method of solving a first-order linear system with constant coefficients.

**Theorem 2.5 :** Eigenvalue Solutions of  $x' = Ax$

Let  $\lambda$  be an eigenvalue of the [constant] coefficient matrix  $A$  of the first-order linear system

$$\frac{dx}{dt} = Ax .$$

If  $v$  is an eigenvector associated with  $\lambda$ , then

$$x(t) = ve^{\lambda t}$$

is a nontrivial solution of the system.

In outline, this the eigenvalue method for solving the  $n \times n$  homogeneous constant-coefficient system  $x' = Ax$  proceeds as follows;

At first the characteristic equation in (2.29) for the eigenvalues  $\lambda_1, \lambda_2, \dots, \lambda_n$  of the matrix  $A$  is solved. Then attempted to find  $n$  linearly independent eigenvectors  $v_1, v_2, \dots, v_n$  associated with these eigenvalues. It is not always possible, but when it is,  $n$  linearly independent solutions are got.

$$x_1(t) = v_1 e^{\lambda_1 t}, \quad x_2(t) = v_2 e^{\lambda_2 t}, \quad \dots, \quad x_n(t) = v_n e^{\lambda_n t} . \quad (2.30)$$

In this case the general solution of  $x' = Ax$  is a linear combination

$$x(t) = c_1 x_1(t) + c_2 x_2(t) + \dots + c_n x_n(t)$$

of these  $n$  solutions.

Now the various cases that can occur will be discussed separately, depending on whether the eigenvalues are distinct or repeated, real or complex (Edwards and Penney,1996).

### 2.3.2.1 Distinct Real Eigenvalues

If the eigenvalues  $\lambda_1, \lambda_2, \dots, \lambda_n$  are real and distinct, then each of them is going to be substituted in turn in Eq.  $(A - \lambda I)v = 0$  and solve for the associated eigenvectors  $v_1, v_2, \dots, v_n$ . In this case it can be proved that the particular solution vectors given in (2.30) are always linearly independent. In any particular example such linear independence can always be verified by using the Wronskian determinant of Chapter 2.2.2 (Edwards and Penney, 1996).

**Example 2.12** Find a general solution of the system

$$\begin{aligned}x'_1 &= 4x_1 + 2x_2, \\x'_2 &= 3x_1 - x_2.\end{aligned}\tag{1}$$

*Solution* The matrix form of the system in (1) is

$$x' = \begin{bmatrix} 4 & 2 \\ 3 & -1 \end{bmatrix} x.\tag{2}$$

The characteristic equation of the coefficient matrix is

$$\begin{aligned}\begin{vmatrix} 4 - \lambda & 2 \\ 3 & -1 - \lambda \end{vmatrix} &= (4 - \lambda)(-1 - \lambda) - 6 \\ &= \lambda^2 - 3\lambda - 10 = (\lambda + 2)(\lambda - 5) = 0,\end{aligned}$$

so we have the distinct real eigenvalues  $\lambda_1 = -2$  and  $\lambda_2 = 5$ .

For the coefficient matrix  $A$  in Eq. (2) the eigenvector equation  $(A - \lambda I)v = 0$  takes the form

$$\begin{bmatrix} 4 - \lambda & 2 \\ 3 & -1 - \lambda \end{bmatrix} \begin{bmatrix} a \\ b \end{bmatrix} = \begin{bmatrix} 0 \\ 0 \end{bmatrix}\tag{3}$$

for the associated eigenvector  $v = [a \ b]^T$ .

**Case 1:**  $\lambda_1 = -2$ . Substitution of the first eigenvalue  $\lambda_1 = -2$  in Eq. (3) yields the system

$$\begin{bmatrix} 6 & 2 \\ 3 & 1 \end{bmatrix} \begin{bmatrix} a \\ b \end{bmatrix} = \begin{bmatrix} 0 \\ 0 \end{bmatrix}$$

that is, the two scalar equations

$$\begin{aligned} 6a + 2b &= 0, \\ 3a + b &= 0. \end{aligned} \quad (4)$$

In contrast with the nonsingular (algebraic) linear systems whose solutions are discussed in Chapter 2.3, the homogeneous linear system in (4) is *singular*-the two scalar equations obviously are equivalent (each being a multiple of the other). Therefore, Eq. (4) has infinitely many nonzero solutions-we can choose  $a$  arbitrarily (but nonzero) and then solve for  $b$ .

Substitution of an eigenvalue  $\lambda$  in the eigenvector equation  $(A - \lambda I)v = 0$  always yields a singular homogeneous linear system, and among its infinity of solutions we generally seek a "simple" solution with small integer values (if possible). Looking at the second equation in (4), the choice  $a = 1$  yields  $b = -3$ , and thus

$$v_1 = \begin{bmatrix} 1 \\ -3 \end{bmatrix}$$

is an eigenvector associated with  $\lambda_1 = -2$  (as is any nonzero constant multiple of  $v_1$ ).

Remark If instead of the "simplest" choice  $a = 1, b = -3$ , we had made another choice  $a = c \neq 0, b = -3c$ , we would have obtained the eigenvector

$$v_1 = \begin{bmatrix} c \\ 3c \end{bmatrix} = c \begin{bmatrix} 1 \\ -3 \end{bmatrix}.$$

Because this is a constant multiple of our previous result, any choice we make leads to (a constant multiple of) the same solution

$$x_1(t) = \begin{bmatrix} 1 \\ -3 \end{bmatrix} e^{-2t}.$$

**Case 2:**  $\lambda_2 = 5$ . Substitution of the second eigenvalue  $\lambda = 5$  in (3) yields the pair



$$\begin{aligned} -a + 2b &= 0 \\ 3a - 6b &= 0 \end{aligned} \quad (5)$$

of equivalent scalar equations. With  $b = 1$  in the first equation we get  $a = 2$ , so

$$v_2 = \begin{bmatrix} 2 \\ 1 \end{bmatrix}$$

is an eigenvector associated with  $\lambda_2 = 5$ . A different choice  $a = 2c, b = c \neq 0$  would merely give a [constant] multiple of  $v_2$ .

These two eigenvalues and associated eigenvectors yield the two solutions

$$x_1(t) = \begin{bmatrix} 1 \\ -3 \end{bmatrix} e^{-2t} \text{ and } x_2(t) = \begin{bmatrix} 2 \\ 1 \end{bmatrix} e^{5t}.$$

They are linearly independent because their Wronskian

$$\begin{vmatrix} e^{-2t} & 2e^{5t} \\ -3e^{-2t} & e^{5t} \end{vmatrix} = 7e^{3t}$$

is nonzero. Hence a general solution of the system in (1) is

$$x(t) = c_1 x_1(t) + c_2 x_2(t) = c_1 \begin{bmatrix} 1 \\ -3 \end{bmatrix} e^{-2t} + c_2 \begin{bmatrix} 2 \\ 1 \end{bmatrix} e^{5t};$$

in scalar form,

$$\begin{aligned} x_1(t) &= c_1 e^{-2t} + 2c_2 e^{5t}, \\ x_2(t) &= -3c_1 e^{-2t} + c_2 e^{5t}. \end{aligned}$$

Figure 2.4 shows some typical solution curves of the system (1). It is seen that two families of hyperbolas sharing the same pair of asymptotes: the line  $x_1 = 2x_2$  obtained from the general solution with  $c_1 = 0$ , and the line  $x_2 = -3x_1$  obtained with  $c_2 = 0$ . Given initial values  $x_1(0) = b_1, x_2(0) = b_2$ , according to Edwards and Penney (1996) it is apparent from the figure that

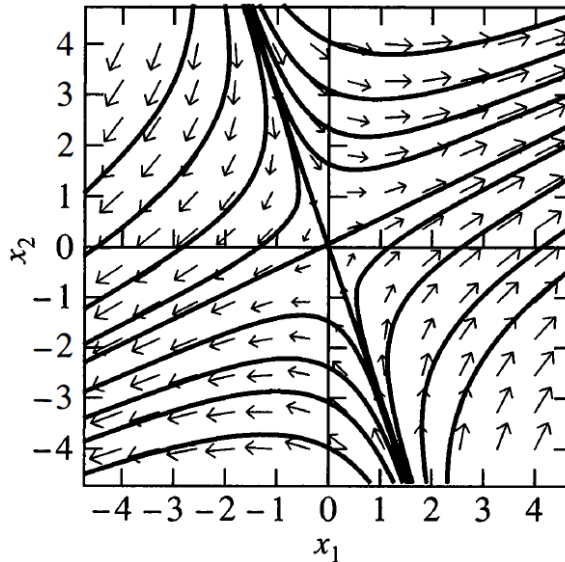

Figure 2.4 Direction field and solution curves for the linear system

$$x'_1 = 4x_1 + 2x_2, x'_2 = 3x_1 - x_2 \text{ from Edwards and Penney (1996)}$$

- If  $(b_1, b_2)$  lies to the right of the line  $x_2 = -3x_1$ , then  $x_1(t)$  and  $x_2(t)$  both tend to  $+\infty$  as  $t \rightarrow +\infty$ ;
- If  $(b_1, b_2)$  lies to the left of the line  $x_2 = -3x_1$ , then  $x_1(t)$  and  $x_2(t)$  both tend to  $-\infty$  as  $t \rightarrow +\infty$ .

### 2.3.2.2 Complex Eigenvalues

Even if some of the eigenvalues are complex, so long as they are distinct the method described previously still yields  $n$  linearly independent solutions. The only complication is that the eigenvectors associated with complex eigenvalues are ordinarily complex valued, so solutions will be complex-valued (Edwards and Penney, 1996).

To obtain real-valued solutions, note that—because we are assuming that the matrix  $A$  has only real entries—the coefficients in the characteristic equation in (2.29) will all be real. Consequently any complex eigenvalues must appear in complex conjugate pairs. Suppose then that  $\lambda = p + qi$  and  $\bar{\lambda} = p - qi$  are such a pair of eigenvalues. If  $v$  is an eigenvector associated with  $\lambda$ , so that

$$(A - \lambda I)v = 0,$$

then taking complex conjugates in this equation yields

$$(A - \bar{\lambda}I)\bar{v} = 0$$

since  $\bar{A} = A$  and  $\bar{I} = I$  (these matrices being real) and the conjugate of a complex product is the product of the conjugates of the factors. Thus the conjugate  $\bar{v}$  of  $v$  is an eigenvector associated with  $\bar{\lambda}$ . Of course the conjugate of a vector is defined component wise; if

$$v = \begin{bmatrix} a_1 + b_1 i \\ a_2 + b_2 i \\ \vdots \\ a_n + b_n i \end{bmatrix} = \begin{bmatrix} a_1 \\ a_2 \\ \vdots \\ a_n \end{bmatrix} + \begin{bmatrix} b_1 \\ b_2 \\ \vdots \\ b_n \end{bmatrix} i = a + bi,$$

then  $\bar{v} = a - bi$ . The complex-valued solution associated with  $\lambda$  and  $v$  is then

$$x(t) = ve^{\lambda t} = ve^{(p+qi)t} = (a + bi)e^{pt}(\cos qt + i \sin qt);$$

that is,

$$x(t) = e^{pt}(a \cos qt - b \sin qt) + ie^{pt}(b \cos qt + a \sin qt).$$

Because the real and imaginary parts of a complex-valued solution are also solutions, we thus get the two real-valued solutions

$$\begin{aligned} x_1(t) &= \text{Re}[x(t)] = e^{pt}(a \cos qt - b \sin qt), \\ x_2(t) &= \text{Im}[x(t)] = e^{pt}(b \cos qt + a \sin qt) \end{aligned} \quad (2.31)$$

associated with the complex conjugate eigenvalues  $p \pm qi$ . It is easy to check that the same two real-valued solutions result from taking real and imaginary parts of  $\bar{v}e^{\bar{\lambda}t}$ . Rather than memorizing the formulas in (2.31), it is preferable in a specific example to proceed as follows;

First find explicitly a single complex-valued solution  $x(t)$  associated with the complex eigenvalue  $\lambda$ ;

Then find the real and imaginary parts  $x_1(t)$  and  $x_2(t)$  to get two independent real-valued solutions corresponding to the two complex conjugate eigenvalues  $\lambda$  and  $\bar{\lambda}$  (Edwards and Penney, 1996).

**Example 2.13** Find a general solution of the system

$$\frac{dx_1}{dt} = 4x_1 - 3x_2,$$

$$\frac{dx_2}{dt} = 3x_1 + 4x_2.$$

*Solution* : The coefficient matrix

$$A = \begin{bmatrix} 4 & -3 \\ 3 & 4 \end{bmatrix}$$

has characteristic equation

$$|A - \lambda I| = \begin{vmatrix} 4 - \lambda & -3 \\ 3 & 4 - \lambda \end{vmatrix} = (4 - \lambda)^2 + 9 = 0.$$

and hence has the complex conjugate eigenvalues  $\lambda = 4 - 3i$  and  $\bar{\lambda} = 4 + 3i$ .

Substituting  $\lambda = 4 - 3i$  in the eigenvector equation  $(A - \lambda I)v = 0$ , we get the equation

$$[A - (4 - 3i)I]v = \begin{bmatrix} 3i & -3 \\ 3 & 3i \end{bmatrix} \begin{bmatrix} a \\ b \end{bmatrix} = \begin{bmatrix} 0 \\ 0 \end{bmatrix}$$

for an associated eigenvalue  $v = [a \ b]^T$ . Division of each row by 3 yields the two scalar equations

$$ia - b = 0,$$

$$a + ib = 0,$$

each of which is satisfied by  $a = 1$  and  $b = i$ . Thus  $v = [1 \ i]^T$

### 2.3.3 Comparison of Methods

The method in applied mathematics can be an effective procedure to obtain analytic and approximate solutions for different types of operator equations. Many scientific and technological problems are modeled mathematically by systems of ordinary differential equations, for example, mathematical models of series circuits and mechanical systems involving several springs attached in series can lead to a system of differential equations. Furthermore, such systems are often encountered in chemical, ecological, biological, and engineering applications. A standard class of problems, for which considerable literature and software exists, is that of initial value problems for first-order systems of ordinary differential equations. Most realistic systems of ordinary differential equations do not have exact analytic solutions, so approximation and numerical techniques must be used. For this reason various methods are given above. Now these solution methods are going to be compared by examples and modelings (Shawagfeh, N., Kaya D. 2003). Firstly in Example 2.7 there is a comparison of solution methods of nonhomogeneous differential equations. Latter in this chapter some examples are given for comparison of solution methods that is mentioned in this project.

**Example 2.14** Find the solution of Euler equation  $x^2y'' - 2xy' - 4y = 0$  for  $x > 0$  and transforming  $y = x^r$ .

*Solution* As in Chapter 2.2, it is obvious that  $y = x^r$ ,  $y' = re^{r-1}$  and  $y'' = r(r-1)e^{r-2}$ . Replacing terms with their place at the equation;

$$x^2[r(r-1)x^{r-2}] - 2x[rx^{r-1}] - 4x^r = 0, \quad x^r[r^2 - 3r - 4] = 0$$

is found. Hence by  $x > 0$ ,  $x^r \neq 0$ , so  $(r^2 - 3r - 4) = 0$ . According to these:

$$r_1 = -1, r_2 = 4,$$

$y = c_1|x|^{r_1} + c_2|x|^{r_2} \Rightarrow y = c_1x^{-1} + c_2x^4 = \frac{c_1}{x} + c_2x^4$  is acquired (Çengel,2013).

**Example 2.15** Euler equations (finding particular solution)

For  $x > 0$ , find the general solution of  $x^2y'' - 2xy' - 4y = 10x$  differential equation.

*Solution* At previous example  $y$  was equal to  $\frac{c_1}{x} + c_2x^4$ . Although right side of the equation is equal to  $10x$  first attempt to solve this question would be  $y_s = Ax + B$ . In any cases, there is no guarantee that solving with method of undetermined coefficients.

$$\text{Since } y'' - \frac{2}{x}y' - \frac{4}{x^2}y = \frac{10}{x} \quad \text{and} \quad y_h = \frac{c_1}{x} + c_2x^4,$$

$$R(x) = \frac{10}{x}, \quad y_1 = \frac{1}{x}, \quad y_2 = x^4.$$

$$\text{And about Wronskian;} W = y_1y_2' - y_1'y_2 = \frac{1}{x}(4x^3) - \left(-\frac{1}{x^2}\right)x^4 = 5x^2. \text{ So;}$$

$$u_1 = - \int \frac{y_2R(x)}{W} dx = - \int \frac{10x^4}{5x^2} dx = -x^2$$

$$u_2 = \int \frac{y_1R(x)}{W} dx = \int \frac{1}{x} \frac{1}{5x^2} dx = -\frac{2}{3x^3}.$$

According to these datas;

$$y_p = u_1y_1 + u_2y_2 = -x^2 \frac{1}{x} - \frac{2}{3x^3x^4} = -\frac{5}{3}x$$

and general solution is

$$y = y_h + y_p = \frac{c_1}{x} + c_2x^4 - \frac{5}{3}.$$

(Çengel,2013).

### **3 INSPECTED ARTICLES**

Three articles of linear ordinary differential equations in economics and medicine are inspected and their methods formed a basis for the study.

There are many articles in the subject linear ordinary differential equations. So it was easy to find applications of linear ordinary differential equations. However, articles are chosen to demonstrate the power of ordinary differential equations. Articles below use differential equations for formulating developments or diseases. By these complex formulas scientists can either found treatments for patients or develop models that are useful for development.

Lately, articles about this subject are about growth models or development analysis. Yet we can use computers to solve complex equations' eigenvalues. So this may led researchers examine that complex equations and improve living conditions.

#### **3.1 Statistical Modeling of Breast Cancer**

Tsokos and Xu's article is published at Istanbul University Journal of the School of Business Administration Vol. 40 No. 1, 2011, 60-71.

One feature of this article is that they study a very important disease which carries a social meaning especially for women. Breast cancer (malignant breast neoplasm) is cancer originating from breast tissue, most commonly from the inner lining of milk ducts or the lobules that supply the ducts with milk, from Sariego. Except that the object of this article is to develop differential equations that will characterize the behavior of the tumor as a function of time. Having such differential equations, the solution of which once plotted will identify the rate of change of tumor size as a function of age. The structures of the differential equations characterize the growth of breast cancer tumor. Once they have developed the differential equations and their solutions, they proceed to validate the quality of the differential system and discuss its usefulness.

With respect to the present article, they will address several questions for not only this study but also for the future researches. The main work in this article is mathematical characterizing the growth of the breast cancer tumor as a function of

age. Secondly in this article they examine if the analytical behavior of breast tumor size (TS) is uniform over all age. Beside this also they study if the mathematical behavior of the tumor size as a function of age is not uniform, can they identify the age intervals where the sizes of the tumor have the same analytical growth behavior? Also they examine can they identify and justify their mathematical behavior of the size of tumor as a function of age over these age intervals? Furthermore can they develop a differential equation in characterizing the change of breast tumor size as a function of age over these age intervals?

In consideration of these questions, results information of 1,000 breast cancer patients had randomly selected from the SEER data. The age of the patients ranges from 33 to 85 years old. However, from the age of 33 to 40 year old patients the data is not complete. Thus, their analysis is focused from the age of 41 to 85 year of age. For better analytical characterization, they decided that their analysis should be based on partitioning the data into three age intervals. Brief description about age groups is given below. Most detailed information is given in third group since it gives the best results with the method they apply.

### **Age Group 1**

This age group consists of 155 breast cancer patients from 41 to 58 years of age. In analysis of the scatter diagram of this age group that is given in the article, a differential equation occurs. Thus, based on the residual analysis they can conclude that the analytical behavior of the tumor size of breast cancer patients given by this equation is a good fit.

Then they proceed to identify the differential equation for the first age group. Let  $x$  represents the patients' age in term of years and the according tumor size is a function,  $T(x)$ , in term of mille meter (mm) then the instantaneous rate of change (IROC) of tumor size is the derivative of the tumor size function with respect to time ( $T'(x)$ ).

The differential equation is given by;



$$\begin{aligned}
T(x) + T'(x) &= 1.764 \times 10^6 - 2.2456 \times 10^5 x + 1.198 \times 10^4 x^2 - 3.38 \times 10^2 x^3 \\
&\quad + 5.351 x^4 - 4.499 \times 10^{-2} x^5 + 1.571 \times 10^{-4} x^6, \\
41 \leq x \leq 58 &\quad (1)
\end{aligned}$$

Thus, the solution of (1) is given by (2). Therefore, if one is interest in obtaining the change of rate of the breast cancer tumor size for a desired age in age group 1, he/she can evaluate the solution of the differential equation at the desired age.

$$\begin{aligned}
\frac{d(T(x))}{d(x)} &= -2.518 \times 10^5 + 2.613 \times 10^4 x - 1.082 \times 10^3 x^2 + 22.3221 \times x^3 \\
&\quad - 0.2297 x^4 + 0.942 \times 10^{-3} x^5, \quad 41 \leq x \leq 58 \quad (2)
\end{aligned}$$

They proceed to evaluate the results given by the solution to the differential equation. They evaluate the accuracy of the results from the differential equation as follows. For example, at age of 41 to 42, the solution to the differential equation estimate the change of rate is -0.04074, where the observed actual rate of change is given by -0.210526 which is obtained from  $ROC = \frac{\text{current year}-\text{previous year}}{\text{previous year}}$ . The difference of the two constitutes the first rate of change residual (ROC residual).

Based on the results, they can conclude that the differential equation gives fairly accurate rate of the change of the breast tumor size as a function of age.

They can utilize the mathematical expressions (1) and (2) with the correction factor of the mean of residual to estimate the rate of the tumor growth for future age.

## Age Group 2

This group consists of 276 patients from 59 to 73 years of age. Same process applied by method that is used at the Age Group 1 for this age group. Difference of this group is that the residuals are small and so is the standard error. These results attest to the good quality of the proposed model for tumor size.

### Age Group 3

This group consists of 308 patients from 73 to 85 years of age. The mathematical function that characterizes the breast cancer tumor size behavior in the given age group is given by

$$T(x) = -2.93789 \times 10^5 + 1.4954 \times 10^4 x - 2.853 \times 10^2 x^2 + 2.4166 x^3 - 7.672 \times 10^{-3} x^4, \quad 74 \leq x \leq 85 \quad (3)$$

Then they check the quality of the fitting by residual analysis of the breast cancer tumor size in Table below.

Age	Actual value	Fitted value	Residual
74	15.16667	14.53395	0.63271232
75	15.26667	16.05426	-0.78759789
76	15.48387	16.699901	-1.20151395
77	17.9	17.06703	0.83296694
78	19.11765	17.57305	1.5445921
79	18.45833	18.44768	0.01065

**Table 3.1 Age Group 3 from Tsokos and Xu (2011)**

Mean of Residual	-6.780781e-18
Standard Deviation of Residual	0.929734
Standard Error of Residual	0.2683911

**Table 3.2 Residuals of Age Group 3 from Tsokos and Xu (2011)**

Thus, based on the residual analysis they can conclude that the analytical behavior of the tumor size of breast cancer patients given by (3) is a good fit. Figure below shows the actual polynomial over the scatter data

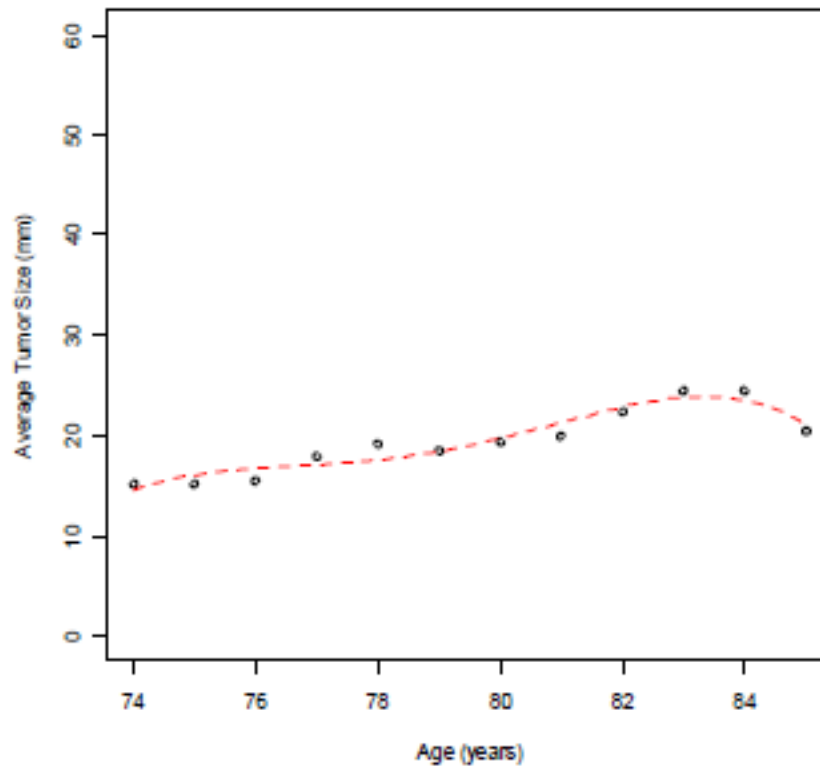
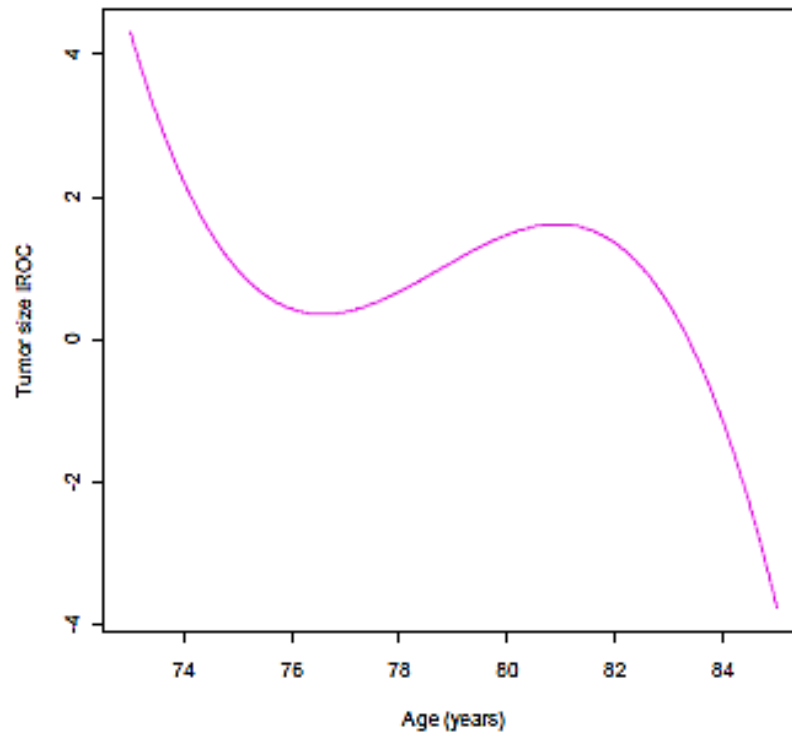

**Figure 3.1 Average Tumor Size x Age tabulation from Tsokos and Xu (2011)**

Now they proceed to identify the differential equation for the third age group. The differential equation is given by the below one.

$$\frac{d(T(x))}{d(x)} = -1.4954 \times 10^4 - 5.705 \times 10^2 x + 7.24988x^2 - 0.03068 \times x^3,$$

$$74 \leq x \leq 85$$



**Figure 3.2 Tumor Size IROC x Age tabulation from Tsokos and Xu (2011)**

The residual analysis they performed on the proposed differential equation of tumor size is given in Table above.

Age	Empirical ROC	DE IROC	Residual
74	0.0065934	-0.030347	0.036941
75	0.014227	0.0967895	-0.082562
76	0.156042	0.090693	0.06534849
77	0.06802498	0.04762	0.0204083
78	-0.0344872	0.0187968	-0.053284

**Table 3.3 Age Group 3 IROC from Tsokos and Xu (2011)**

Mean of Residual	0.001199553
Standard Deviation of Residual	0.04160096
Standard Error of Residual	0.01200916

**Table 3.4 Residuals of Age Group 3 IROC from Tsokos and Xu (2011)**

As seen from Table above the residuals are small and so is the standard error. These results attest to the good quality of the proposed model for tumor size.

Furthermore they can conclude from their extensive statistical analysis that all of the four parts of the differential equations have good quality.

This powerful model which helps to constitute a good quality slope is useful for a number of following reasons. Firstly it can be used to identify the rate of change of the growth of the breast cancer tumor size. Secondly one can also use the proposed differential equation systems to generate various scenarios of the tumor size as a function of different values of the age. And lastly people can use these differential equation systems to predict the rate of change of the growth of tumor for different ages.

As a result about this article, they extract a random sample 1,000 breast cancer patients from Surveillance Epidemiology and End Results (SEER) data base and develop differential equations to obtain information about the rate of growth of breast cancer tumor. They found the breast cancer tumor size is not uniform over all age. The sample data was partitioned into three intervals groups as a function of age for better analytical tractability, that is, the age group from 41 to 58, age group from 59 to 73 and age group from 74 to 85. For each age group, they develop a differential equation that can be used to obtain the rate of growth of the malignant tumor size. They justified the mathematical behavior of the function they proposed by residual analysis.

### **3.2 Analysis of Economic Growth Differential Equation**

Asfiji, Isfahane, Dastjerdi & Fakhar's article is published at International Journal of Business and Behavioral Sciences Vol. 2, No.11 in November 2012.

In this article a new analysis of the population growth rate in the frequency space is described with mathematical logic and economic reasoning, so that, firstly, to a higher level of capital per capita, or at least equal to the Solow growth model reaches Second, the limits of saturation (Carrying-Capacity) is not, and ultimately, population growth rates have an impact on long-term per capita amounts. The initial classic assumption is changed in this article based on the available frequencies in the population growth equation. Finally, the last is based on the feasibility of any population growth rate with population size in the frequency space is proved.

Terms in this article are Solow growth model, Population growth rate and Fourier series. Let's define these terms in order to invest this article deeper.

Starting with Solow growth model, in his classic 1956 article, Solow proposed that we begin the study of economic growth by assuming a standard neoclassical production function with decreasing returns to capital. Taking the rates of saving and population growth as exogenous, he showed that these two variables determine the steady-state level of income per capita. Because saving and population growth rates vary across countries, different countries reach different steady states. Solow's model gives simple testable predictions about how these variables influence the steady-state level of income. The higher the rate of saving, the richer the country. The higher the rate of population growth, the poorer the country (Mankiw, 1992). So giving a worker a second computer does not double his output.

Solow's model takes the rates of saving, population growth, and technological progress as exogenous. There are two inputs, capital and labor, which are paid their marginal products. The steady-state capital-labor ratio is related positively to the rate of saving and negatively to the rate of population growth. The central predictions of the Solow model concern the impact of saving and population growth on real income. The model assumes that factors are paid their marginal products, it predicts not only the signs but also the magnitudes of the coefficients on saving and population growth.

The population growth rate is discussed in many places for this article so a broad definition about is necessary. Population growth rate is the summary parameter of trends in population density or abundance. It tells us whether density and abundance are increasing, stable or decreasing, and how fast they are changing. Population growth rate describes the per capita rate of growth of a population, either as the factor by which population size increases per year, conventionally given the symbol  $\lambda$  ( $= \frac{N_{t+1}}{N_t}$ ), or as  $r = \ln \lambda$ . Generally here, population growth rate will refer to  $r$ .  $\lambda$  is referred to variously as 'finite growth rate', 'finite rate of increase', 'net reproductive rate' or 'population multiplication rate'.  $r$  is known as 'rate of natural increase', 'instantaneous growth rate', 'exponential rate of increase' or 'fitness'. In the simplest population model all individuals in the population are assumed equivalent, with the same death rates and birth rates, and there is no migration in or



out of the population, so exponential growth occurs; in this model, population growth rate =  $r$  = instantaneous birth rate - instantaneous death rate (Sibly and Hone, 2002).

Efforts to model populations with changing vital rates have been impeded by the lack of closed form relationships between vital rates and the resulting births. Sinusoid ally fluctuating vital rates were studied by Coale (1972) and Tuljapurkar (1985) using a Fourier series approach to the birth function. To obtain an approximate solution, however, they needed to assume a small amplitude of oscillation and consider only the first harmonic of the Fourier series.

The explanation was given about the Fourier series, it is possible that the net reproduction function is a different frequency and direction of these frequencies is a function of birth in a stable condition. As a result of the exponential Fourier series with period  $T$  and frequency  $\omega$  is as follows (Sochen and Kim,1997):

$$R(t) = \exp \left[ \frac{1}{2} a_0 + \sum_m a_m \cos(m\omega t) + \sum_m b_m \sin(m\omega t) \right] \quad (1)$$

Now, the net production function and simplified mathematical equations with respect to the relationship that exists between the birth of the path can be achieved, so that they can come to the following function:

$$g(t) = \exp \left[ \frac{1}{2} \left\{ \frac{a_0 t}{a} + \sum_m a_m \left[ \sin(m\omega t) \cot \left( \frac{1}{2} m\omega A \right) + \cos(m\omega t) - 1 \right] + \sum_m b_m \left[ \sin(m\omega t) + (1 - \cos(m\omega t)) \cot \left( \frac{1}{2} m\omega A \right) \right] \right\} \right] \quad (2)$$

Change is here in the logistic growth model and the frequency equation is applied to the growth of our workforce. It is for this they consider the three cases, the third mode is the only long-term population growth rates converge to a fixed rate to a fixed rate, other states are not converging.

**First case:**

$$L(t) = \left[ \sum_m a_m \cos(m\omega t) + \sum_m b_m \sin(m\omega t) \right] * a e^{nt} \quad (3)$$

$$\lim_{t \rightarrow \infty} n(t) = \frac{\dot{L}(t)}{L(t)} = \gamma(t)$$

This long term viewpoint on population growth rate to a fixed rate does not converge.

**Second case:**

$$L(t) = ae^{n*(\sum_m a_m \cos(m\omega t) + \sum_m b_m \sin(m\omega t))} \quad (4)$$

$$\lim_{t \rightarrow \infty} n(t) = \frac{\dot{L}(t)}{L(t)} = \beta(t)$$

In this case, the long term population growth rate depends on the viewpoint does not converge to a constant growth rate.

**Third case:**

$$L(t) = \left[ \sum_m a_m \cos(m\omega t) + \sum_m b_m \sin(m\omega t) \right] + ae^{nt} \quad (5)$$

Frequency is limited by the number of sentences.

$$\dot{L}(t) = \frac{\partial L}{\partial t} = \sum_m c_m \cos(m\omega t) + \sum_m d_m \sin(m\omega t) + ane^{nt} \quad (6)$$

$$n(t) = \frac{\dot{L}(t)}{L(t)} = \frac{\sum_m c_m \cos(m\omega t) + \sum_m d_m \sin(m\omega t) + ane^{nt}}{\sum_m a_m \cos(m\omega t) + \sum_m b_m \sin(m\omega t) + ae^{nt}}$$

Proof that long-term in the equation is convergent to a constant growth rate is given below:

$$\begin{aligned}
\lim_{t \rightarrow \infty} n(t) &= \lim_{t \rightarrow \infty} F(t, \omega, m, n) \\
&= \lim_{t \rightarrow \infty} \frac{\sum_m c_m \cos(m\omega t) + \sum_m d_m \sin(m\omega t) + a n e^{nt}}{\sum_m c_m \cos(m\omega t) + \sum_m d_m \sin(m\omega t) + a e^{nt}} \\
&= \lim_{t \rightarrow \infty} \frac{a e^{nt} \left( \frac{\sum_m c_m \cos(m\omega t) + \sum_m d_m \sin(m\omega t)}{a e^{nt}} + n \right)}{a e^{nt} \left( \frac{\sum_m c_m \cos(m\omega t) + \sum_m d_m \sin(m\omega t)}{a e^{nt}} + 1 \right)} \\
&= n \quad (7)
\end{aligned}$$

They here note that the number of clauses  $m$  limit is considered. Case 3 is very accurate is this model, the frequency rate of population growth in the long run to a growth rate of fixed convergent, but during the period of transition population growth rate oscillations is faced with the oscillations of the cosine and sine terms can be explained and this analysis is more consistent with economic realities and facts (Asfiji et al. 2012).

The main difference here, the population growth rate is not constant but a function of time is longer. In conclusion reached advanced differential equations that cannot be solved simply invest the time and cannot be simply the plateau value account said.

The answer to this kind of Bernoulli equation can be expressed as a whole. In general, if the Bernoulli equation as followed:

$$\dot{x}(t) = a(t)x + b(t)$$

The rate of population growth is a very interesting concept. The four parameters on population growth rate are impressive. The basic premise of classical growth only one parameter ( $n$ ) has an effect on growth rate, as well as the logistic growth model only two parameters ( $n, t$ ) on the growth rate affects. Such a result can gather that this is more accurate than previous assumptions and is more complete.

Another very important point in this model, it should be mentioned, is that in the long run, population growth rates will converge towards a fixed rate, that these results are compatible with the basic Solow growth model because of logistics, converge towards a long-term growth rate is zero and the model to explain changes in population growth rate assumptions of classical growth models.

If the analysis of the Solow growth model - Swan under the assumption that

$$\dot{r} = sf(r) - (\delta + n(t))r$$

Where:

$$n(t) = F(t, \omega, m, n)$$

in the logistic growth model in the steady-state analysis of this equation, they finally reached the following equation:

$$\begin{aligned} \lim_{t \rightarrow \infty} x(t) &= \lim_{t \rightarrow \infty} \frac{b(t)}{a(t)} = \lim_{t \rightarrow \infty} \frac{sA(1 - \beta)}{-(1 - \beta) \left( \frac{\sum_m c_m \cos(m\omega t) + \sum_m d_m \sin(m\omega t)}{\sum_m a_m \cos(m\omega t) + \sum_m b_m \sin(m\omega t)} + \delta \right)} \\ &= \frac{sA(1 - \beta)}{-(1 - \beta)(n + \delta)} = -\frac{sA}{\delta + n} \end{aligned}$$

$$\tilde{r} = \left( \frac{sA}{\delta + n} \right)^{\frac{1}{1-\beta}}$$

The economic growth theory usually the population growth is considered as an exponential growth rate; although this seems as a non-realistic assumption. According to Solow, the existence of a positive growth rate for population, for the purpose of explaining the economic growth is essential, but once an economic system determines its population growth path based on an exogenous rate. Any increase in the population growth rate (in ration to the previous rate) would describe lower per capita capital and production in the transition phase of the economy.

In this article they change the initial classic assumption and obtain the population growth rate based on the frequencies inherent in the population growth equation in accordance with the Four cycles. Here the Fourier series approach in adapted. To apply the Fourier series approach our equation should contain a series of frequencies, but since its derivative, that is the population growth rate has frequency therefore the main equation of population growth rate.

### 3.3 Numerical Solution of Vintage Capital Growth Models

Boucekkine, Licandro & Paul's article is published at Journal of Economic Dynamics and Control Working Paper 95-59 Economic Series 29 in December 1995.

In this article, they examine techniques for the analytical and numerical solution of state-dependent differential-difference equations which is a subject of ordinary differential equations. Such equations occur in the continuous time modelling of vintage capital growth models, which form a particularly important class of models in modern economic growth theory. The theoretical treatment of non-state-dependent differential-difference equations in economics has already been discussed by Benhabib and Rustichini (1991). In general, though, the state-dependence of a model prevents its analytical solution in all but the simplest of cases. They review a numerical method for solving state-dependent models, using some simple examples to illustrate their discussion. In addition, they analyze the Solow vintage capital growth model. They conclude by mentioning a crucial unresolved issue related to this topic.

Beneficial part of this article to this project is that they had applied solving methods of ordinary differential equations as functions of macroeconomics. So application area of my project expanded. Also important part of this article is it examines short-term dynamics of the economy while previous one examines long-term.

This article can be a good reference for researchers since it has numerical solutions either. Moreover this article used the method of Solow likewise the previous article. Therefore a detailed information about Solow model is given below.

As introduced in the previous article, one of the most known models of economic growth is the neoclassical model or the Solow-Swan model of growth, as it is known in the specialized macroeconomic literature. This model is an extension of the growth model Harrod-Domar (1946); and the extension is represented by including in the model a new term: increase of productivity. In this new model, the new capital is more valuable than the old capital, because it appears as a result of the improvement of technology during the time (Cai, 2014).

In the classical Solow-Swan model, saving rate, technological level, capital depreciation, and population growth rate are assumed to be fixed positive constants. However, they vary in the process of the economic growth and appear in different forms in the different periods. The growth rate of population presents an inverted-U form in the demographic transition, the growth of technology appears in the S shape in some periods, and the saving rate varies with the age structure (Cai, 2014).

The effect of different types of technological change on the economic growth is inquired by using the generalized Solow-Swan model. It is proved that the economy with higher technological level has higher per capita capital than that with lower technological level under the Hicks or Solow neutral technology. This implies that a developing economy can catch up a developed economy if it keeps a higher technological growth rate. When the technological level is persistent oscillation, the economy presents long-term fluctuation (Cai, 2014).

With some remarks and numerical solutions they examined The Solow Vintage Capital Growth Model that is been introduced before. For an economic application of their algorithm, they consider a general formulation of the vintage capital growth model of Solow et al (1966). The structural equations of the model for  $t \geq 0$  are:

$$y(t) = \int_{t-T(t)}^t i(z)dz, \quad (1)$$

$$l(t) = \int_{t-T(t)}^t i(z)\exp\{-\gamma(z)z\}dz, \quad (2)$$

$$i(t) = sy(t), \quad (3)$$

Where  $y(t)$  is production,  $l(t)$  is labour demand,  $i(t)$  is investment and is specified for  $t < 0$ , and  $T(t)$  is the age of the oldest machine still in use at time  $t$ . The parameter  $s \in (0,1)$  and represents the saving rate.

The age structure of the technology is represented by equations (1) and (2), the production and labour demand respectively.

By differentiating the system (1)-(3), and after some elementary substitutions, for  $t \geq 0$  they obtain

$$y'(t) = sy(t)(1 - R(t)),$$

$$T'(t) = 1 - \frac{i(t)}{i(t - T(t))} \times R(t),$$

$$i'(t) = sy'(t),$$

where

$$R(t) = \frac{\exp\{-\gamma(t)t\}}{\exp\{-\gamma(t - T(t))(t - T(t))\}}$$

The initial conditions  $y(0), T(0)$  and  $i(0)$  are obtained from (1)-(3) by putting  $t=0$ . As Solow showed, if  $\gamma(t)$  is constant ( $\gamma(t) = \gamma > 0$ ) and  $s > \gamma$ , then the economy converges to a balanced growth path.

In this article, they examined techniques for the solution of state-dependent DDEs, using simple examples to illustrate the arguments. They also provided an economic application as an example of the useful insight that can be gained from numerical simulations. However, this article is designed more to stimulate interest in the field of computational economics rather than to provide definitive statements about vintage capital growth models, and in particular the SVCMM.

A major issue still to be resolved is the numerical solution of so-called mixed-DDEs, namely DDEs with both endogenous lags and leads. The numerical techniques presented in this article only permit models with lags to be solved. However they can be easily adapted to solve equations that only have leads, so long as the "final solution" is specified. The solution is computed by making the substitution  $t \rightarrow -s$  to obtain a normal DDE. This idea was suggested, for example, by Bellman and Cooke (1963), Chapter 3, for fixed leads. However, these solution techniques cannot be applied to mixed-DDEs. But, as stated by Boucekkine et al (1995), such mixed-delay systems do occur in the general formulation of the Ramsey vintage capital growth model. In the SVCMM, since investment is proportional to production, the

replacement decisions are only dependent on previously calculated quantities. Although the general vintage capital growth model should include a backward-looking component (representing the history of capital accumulation within the economy), it should also include a forward-looking component (representing investment decisions which are dependent on future profits, and, in particular, on the life time of these machines).

A mixed-delay model was recently analyzed by Caballero and Hammour (1994), under the assumption that the solutions are periodic. Having assumed that the solutions are periodic, they use a multiple-shooting technique to compute the one-period solution path and then use a predictor-corrector scheme to extend the solution to the whole real-time interval. Although Caballero and Hammour fail to justify their periodicity assumption and do not rigorously establish the convergence of their numerical method, their simulations are certainly worthwhile as they highlight the extreme difficulty of solving mixed-DDEs. However, their periodicity assumption does mean that their approach cannot be used to solve general mixed-DDEs. In fact, there exists very little in the mathematical literature on the numerical solution of mixed-DDEs.

This situation is the same as the one faced by economists at the beginning of the eighties for the numerical solution of non-linear rational expectation models with both lags and leads. Their numerical approach consists of simultaneously solving the modelling equations on a fixed time interval. Unfortunately, the solution technique discussed in this paper cannot be applied in the same manner. One strategy that appears to be feasible is to combine the numerical techniques mentioned in this paper with a predictor-corrector strategy. However, this task is far from trivial, and they expect it to stimulate further research and debate.

### **3.4 Synthesis**

A differential equation is an equation involving an unknown function and its derivatives. The subject of differential equations possesses a large and important area of application. It finds very wide applications in various areas of economics, biologic, mechanical, electrical, mathematics. 3 articles about linear ordinary that is applied to differential equations are given above. Asfiji et al. changed the initial classic assumption and obtain the population growth rate based on the frequencies inherent



in the population growth equation in accordance with the Four cycles, Boucekine et al. examine techniques for the analytical and numerical solution of state-dependent differential-difference equations which is a subject of ordinary differential equations that occur in the continuous time modelling of vintage capital growth models, which form a particularly important class of models in modern economic growth theory, and Tsokos and Xu extracted a random sample 1,000 breast cancer patients from Surveillance Epidemiology and End Results (SEER) data base and develop differential equations to obtain information about the rate of growth of breast cancer tumor in their study.

By examining three articles above, these implications can be made for solution methods of linear ordinary differential equations;

- Linear ordinary differential equations are applicable for many application areas in many disciplines.
- It is a common subject and it also can be a good source for future research.
- Linear ordinary differential equations are compatible with computer programs. In fact, some of them can only be solved by using computers. For that matter, it make it easier to examine statistical data or getting a formula from the numerical experiments.

To understand this method in detail, applications of linear ordinary differential equations are given in next chapter.

## 4 APPLICATIONS OF LINEAR DIFFERENTIAL EQUATIONS

In this chapter some problems which include linear ordinary differential equations are given and their solutions are given below to show how linear ordinary differential equations can be applied at various problems that are builded for improving our lives. Applications are given as Economic, Biological, Mechanic, Electric.

### 4.1 Economic Problems

While inspecting economics, first thing to be said is of course growth and decay problems. So it is going to be examined below by detailed auxiliary problems.

Let  $N(t)$  denote the amount of substance (or population) that is either growing or decaying. If we assume that  $dN/dt$ , the time rate of change of this amount of substance, is proportional to the amount of substance present. Then  $dN/dt = kN$ , or

$$\frac{dN}{dt} - kN = 0 \quad (4.1)$$

where  $k$  is the constant of proportionality (Bronson and Costa, 2006).

It is assumed that  $N(t)$  is a differentiable, hence continuous, function of time. For population problems, where  $N(t)$  is actually discrete and integer-valued, this assumption is incorrect. Nonetheless, (4.1) still provides a good approximation to the physical laws governing such a system (See Problem 4.3) (Bronson and Costa, 2006). After giving the model of these kind of differential equations now it is possible to solve economic problems.

#### Problem 4.1

A person places \$20,000 in a savings account which pays 5 percent interest per annum, compounded continuously. Find (a) the amount in the account after three years, and (b) the time required for the account to double in value, presuming no withdrawals and no additional deposits.

Let  $N(t)$  denote the balance in the account at any time  $t$ . Initially,  $N(0) = 20,000$ . The balance in the account grows by the accumulated interest payments, which are proportional to the amount of money in the account. The constant of proportionality is the interest rate. In this case,  $k = 0.05$  and Eq. (4.1) becomes

$$\frac{dN}{dt} - 0.05N = 0$$

This differential equation is both linear and separable. Its solution is

$$N(t) = ce^{0.05t} \quad (1)$$

At  $t = 0$ ,  $N(0) = 20,000$ , which when substituted into (1) yields

$$20,000 = ce^{0.05(0)} = c$$

With this value of  $c$ , (1) becomes

$$N(t) = 20,000e^{0.05t} \quad (2)$$

Equation (2) gives the dollar balance in the account at any time  $t$ .

(a) Substituting  $t = 3$  into (2), we find the balance after three years to be

$$N(3) = 20,000e^{0.05(3)} = 20,000(1.161834) = \$23,236.68$$

(b) We seek the time  $t$  at which  $N(t) = \$40,000$ . Substituting these values into (2) and solving for  $t$ , we obtain

$$40,000 = 20,000e^{0.05t}$$

$$2 = e^{0.05t}$$

$$\ln|2| = 0.05t$$

$$t = \frac{1}{0.05} \ln|2| = 13.86 \text{ years (Bronson and Costa, 2006).}$$

### Problem 4.2

A person places \$5000 in an account that accrues interest compounded continuously. Assuming no additional deposits or withdrawals, how much will be in the account after seven years if the interest rate is a constant 8.5 percent for the first four years and a constant 9.25 percent for the last three years?

Let  $N(t)$  denote the balance in the account at any time  $t$ . Initially,  $N(0) = 5000$ . For the first four years,  $k = 0.085$  and Eq. (4.1) becomes

$$\frac{dN}{dt} - 0.085N = 0$$

Its solution is

$$N(t) = ce^{0.085t} \quad (0 \leq t \leq 4) \quad (1)$$

At  $t = 0$ ,  $N(0) = 5000$ , which when substituted into (1) yields

$$5000 = ce^{0.085(0)} = c$$

And (1) becomes

$$N(t) = 5000e^{0.085t} \quad (0 \leq t \leq 4) \quad (2)$$

Substituting  $t = 4$  into (2), we find the balance after four years to be

$$N(t) = 5000e^{0.085(4)} = 5000(1.404948) = \$7024.74$$

This amount also represents the beginning balance for the last three-year period.

Over the last three years, the interest rate is 9.25 percent and (4.1) becomes

$$\frac{dN}{dt} - 0.0925N = 0 \quad (4 \leq t \leq 7)$$

Its solution is

$$N(t) = ce^{0.0925t} \quad (4 \leq t \leq 7) \quad (3)$$

At  $t = 4$ ,  $N(4) = \$7024.74$ , which when substituted into (3) yields

$$7024.74 = ce^{0.0925(4)} = c(1.447735) \text{ or } c = 4852.23$$

And (3) becomes

$$N(t) = 4852.23e^{0.0925t} \quad (4 \leq t \leq 7) \quad (4)$$

Substituting  $t = 7$  into (4), we find the balance after seven years to be

$$N(7) = 4852.23e^{0.0925(7)} = 4852.23(1.910758) = \$9271.44$$

(Bronson and Costa, 2006).

### Problem 4.3

The population of a certain country is known to increase at a rate proportional to the number of people presently living in the country. If after two years the population has doubled, and after three years the population is 20,000, estimate the number of people initially living in the country.

Let  $N$  denote the number of people living in the country at any time  $t$ , and let  $N_0$  denote the number of people initially living in the country. Then, from (4.1),

$$\frac{dN}{dt} - kN = 0$$

which has the solution

$$N = ce^{kt} \quad (1)$$

At  $t = 0$ ,  $N = N_0$ ; hence, it follows from (1) that  $N = ce^{k(0)}$  or that  $c = N_0$ . Thus,

$$N = N_0e^{kt} \quad (2)$$

At  $t = 2$ ,  $N = 2N_0$ . Substituting these values into (2), we have

$$2N_0e^{2k} \text{ from which } k = \frac{1}{2}\ln 2 = 0.347$$

Substituting this value into (2) gives

$$N = N_0e^{0.347t} \quad (3)$$

At  $t = 3$ ,  $N = 20,000$ . Substituting these values into (3), we obtain

$$20,000 = N_0e^{(0.347)(3)} = N_0(2.832) \text{ as } N_0 = 7062$$

(Bronson and Costa, 2006).

## 4.2 Biologic Problems

Not only economic problems use growth and decay equations for solutions, but also biologic problems do. The essential function (4.1) is going to be used for solving biologic problems.

### Problem 4.4

Five mice in a stable population of 500 are intentionally infected with a contagious disease to test a theory of epidemic spread that postulates the rate of change in the infected population is proportional to the product of the number of mice who have the disease with the number that are disease free. Assuming the theory is correct, how long will it take half the population to contract the disease?

Let  $N(t)$  denote the number of mice with the disease at time  $t$ . We are given that  $N(0) = 5$ , and it follows that  $500 - N(t)$  is the number of mice without the disease at time  $t$ . The theory predicts that

$$\frac{dN}{dt} = kN(500 - N) \quad (1)$$

where  $k$  is a constant of proportionality. This equation is different from (4.1) because the rate of change is no longer proportional to just the number of mice who have the disease. Equation (1) has the differential form

$$\frac{dN}{N(500 - N)} - kdt = 0 \quad (2)$$

which is separable. Using partial fraction decomposition, we have

$$\frac{1}{N(500 - N)} = \frac{1}{500N} + \frac{1}{500 - N}$$

hence (2) may be rewritten as

$$\frac{1}{500} \left( \frac{1}{N} + \frac{1}{500 - N} \right) dN - kdt = 0$$

Its solution is

$$\frac{1}{500} \int \left( \frac{1}{N} + \frac{1}{500 - N} \right) dN - \int kdt = c$$

or

$$\frac{1}{500} (\ln|N| - \ln|500 - N|) - kt = c$$

which may be rewritten as

$$\ln \left| \frac{N}{500 - N} \right| = 500(c + kt)$$

$$\frac{N}{500 - N} = e^{500(c+kt)} \quad (3)$$

But  $e^{500(c+kt)} = e^{500c} e^{kt}$ . Setting  $c_1 = e^{500c}$ , we can write (3) as

$$\frac{N}{500 - N} = c_1 e^{500kt} \quad (4)$$

At  $t = 0, N = 5$ . Substituting these values into (4), we find

$$\frac{5}{495} = c_1 e^{500k(0)} = c_1$$

so  $c_1 = 1/99$  and (4) becomes

$$\frac{N}{500 - N} = \frac{1}{99} e^{500kt} \quad (5)$$

(Bronson and Costa, 2006).

### 4.3 Mechanic Problems

In this section applications of linear ordinary differential equations are given by subchapters as falling body problems and spring problems.

#### 4.3.1 Falling Body Problems

Consider a vertically falling body of mass  $m$  that is being influenced only by gravity  $g$  and an air resistance that is proportional to the velocity of the body. Assume that both gravity and mass remain constant and, for convenience, choose the downward direction as the positive direction.

**Newton's second law of motion:** The net force acting on a body is equal to the time rate of change of the momentum of the body; or, for constant mass,

$$F = m \frac{dv}{dt} \quad (4.2)$$

where  $F$  is the net force on the body and  $v$  is the velocity of the body, both at time  $t$  (Bronson and Costa, 2006).

For the problem at hand, there are two forces acting on the body: (1) the force due to gravity given by the weight  $w$  of the body, which equals  $mg$ , and (2) the force



due to air resistance given by  $-kv$ , where  $k \geq 0$  is a constant of proportionality. The minus sign is required because this force opposes the velocity; that is, it acts in the upward, or negative, direction (see Fig. 4.1). The net force  $F$  on the body is, therefore,  $F = mg - kv$ . Substituting this result into (4.2), we obtain

$$mg - kv = m \frac{dv}{dt} \quad \text{or} \quad \frac{dv}{dt} + \frac{k}{m}v = g \quad (4.3)$$

as the equation of motion for the body.

If air resistance is negligible or nonexistent, then  $k = 0$  and (4.3) simplifies to

$$\frac{dv}{dt} = g \quad (4.4)$$

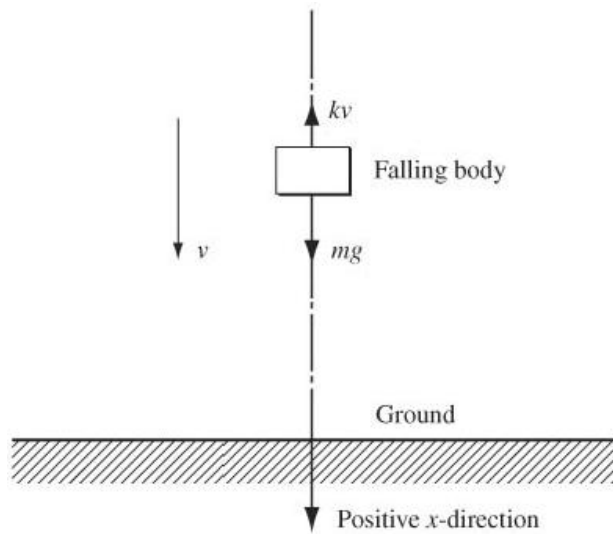

**Figure 4.1** Falling body with air resistance from Bronson and Costa (2006)

(See Problem 4.5) When  $k > 0$ , the limiting velocity  $v_l$  is defined by

$$v_l = \frac{mg}{k} \quad (4.5)$$

Caution: Equations (4.3), (4.4), and (4.5), are valid only if the given conditions are satisfied. These equations are not valid if, for example, air resistance is not

proportional to velocity but to the velocity squared, or if the upward direction is taken to be the positive direction (Bronson and Costa, 2006). (See Problems 4.6 and 4.7)

### Problem 4.5

A body of mass 5 slugs is dropped from a height of 100 ft with zero velocity. Assuming no air resistance, find (a) an expression for the velocity of the body at any time  $t$ , (b) an expression for the position of the body at any time  $t$ , and (c) the time required to reach the ground.

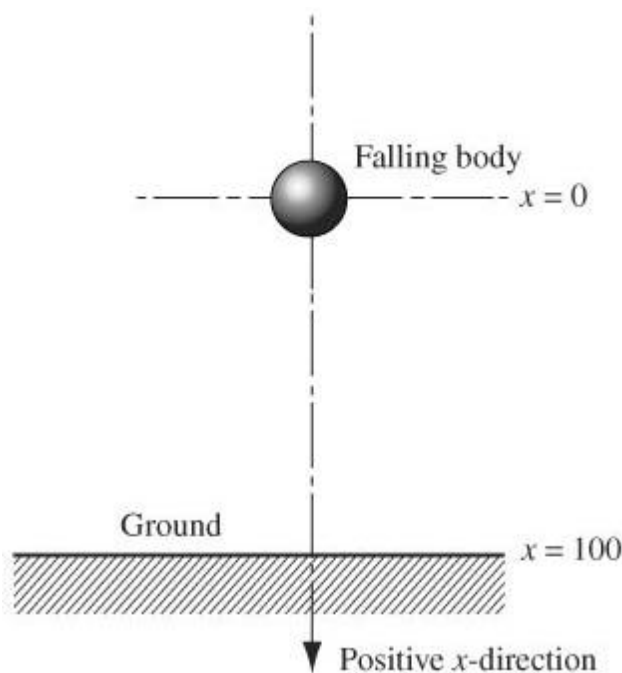

Figure 4.2 Falling Body from Bronson and Costa (2006)

- (a) Choose the coordinate system as in Fig. 4.2. Then, since there is no air resistance, (4.4) applies:  $dv/dt = g$ . This differential equation is linear or, in differential form, separable; its solution is  $v = gt + c$ . When  $t = 0, v = 0$  (initially the body has zero velocity); hence  $0 = g(0) + c$ , or  $c = 0$ . Thus,  $v = gt$  or, assuming  $g = 32\text{ft}/\text{sec}^2$ ,

$$v = 32t \quad (1)$$

(b) Recall that velocity is the time rate of change of displacement, designated here by  $x$ . Hence,  $v = dx/dt$ , and (1) becomes  $dx/dt = 32t$ . This differential equation is also both linear and separable; its solution is

$$x = 16t^2 + c_1 \quad (2)$$

But at  $t = 0$ ,  $x = 0$  (see Fig. 4.2). Thus,  $0 = (16)(0)^2 + c_1$ , or  $c_1 = 0$ . Substituting this value into (2), we have

$$x = 16t^2 \quad (3)$$

(c) We require  $t$  when  $x = 100$ . From (3)  $t = \sqrt{(100)/(16)} = 2.5$  sec

(Bronson and Costa, 2006).

#### **Problem 4.6**

A body of mass  $m$  is thrown vertically into the air with an initial velocity  $v_0$ . If the body encounters an air resistance proportional to its velocity, find (a) the equation of motion in the coordinate system of Fig. 4.3, (b) an expression for the velocity of the body at any time  $t$ , and (c) the time at which the body reaches its maximum height.

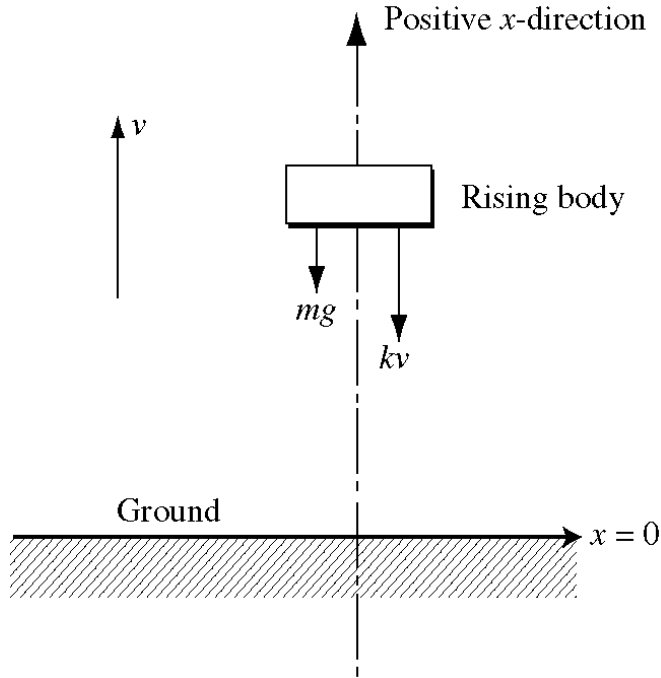

**Figure 4.3 Rising body from Bronson and Costa (2006)**

- (a) In this coordinate system, Eq. (4.3) may not be the equation of motion. To derive the appropriate equation, we note that there are two forces on the body: (1) the force due to the gravity given by  $mg$  and (2) the force due to air resistance given by  $kv$ , which will impede the velocity of the body. Since both of these forces act in the downward or negative direction, the net force on the body is  $-mg - kv$ . Using (4.2) and rearranging, we obtain

$$\frac{dv}{dt} + \frac{k}{m}v = -g \quad (1)$$

as the equation of motion.

- (b) Equation (1) is a linear differential equation, and its solution is  $v = ce^{-(k/m)t} - mg/k$ . At  $t = 0$ ,  $v = v_0$ ; hence  $v_0 = ce^{-(k/m)0} - (mg/k)$ , or  $c = v_0 + (mg/k)$ . The velocity of the body at any time  $t$  is

$$v = \left( v_0 + \frac{mg}{k} \right) e^{-(k/m)t} - \frac{mg}{k} \quad (2)$$

(c) The body reaches its maximum height when  $v = 0$ . Thus, we require  $t$  when  $v = 0$ . Substituting  $v = 0$  into (2) and solving for  $t$ , we find

$$0 = \left(v_0 + \frac{mg}{k}\right) e^{-(k/m)t} - \frac{mg}{k}$$

$$e^{-(k/m)t} = \frac{1}{1 + \frac{v_0 k}{mg}}$$

$$-(k/m)t = \ln\left(\frac{1}{1 + \frac{v_0 k}{mg}}\right)$$

$$t = \frac{m}{k} \ln\left(1 + \frac{v_0 k}{mg}\right)$$

(Bronson and Costa, 2006).

#### Problem 4.7

A body of mass 2 slugs is dropped with no initial velocity and encounters an air resistance that is proportional to the square of its velocity. Find an expression for the velocity of the body at any time  $t$ .

The force due to air resistance is  $-kv^2$ ; so that Newton's second law of motion becomes

$$m \frac{dv}{dt} = mg - kv^2 \quad \text{or} \quad 2 \frac{dv}{dt} = 64 - kv^2$$

Rewriting this equation in differential form, we have

$$\frac{2}{64 - kv^2} dv - dt = 0 \quad (1)$$

which is separable. By partial fractions,

$$\frac{2}{64 - kv^2} = \frac{2}{(8 - \sqrt{kv})(8 + \sqrt{kv})} = \frac{1/8}{8 - \sqrt{kv}} + \frac{1/8}{8 + \sqrt{kv}}$$

Hence (1) can be rewritten as

$$\frac{1}{8} \left( \frac{1}{8 - \sqrt{kv}} + \frac{1}{8 + \sqrt{kv}} \right) dv - dt = 0$$

This last equation has as its solution

$$\frac{1}{8} \int \left( \frac{1}{8 - \sqrt{kv}} + \frac{1}{8 + \sqrt{kv}} \right) dv - \int dt = c$$

or

$$\frac{1}{8} \left[ -\frac{1}{\sqrt{k}} \ln|8 - \sqrt{kv}| + \frac{1}{\sqrt{k}} \ln|8 + \sqrt{kv}| \right] - t = c$$

which can be rewritten as

$$\ln \left| \frac{8 + \sqrt{kv}}{8 - \sqrt{kv}} \right| = 8\sqrt{kt} + 8\sqrt{kc}$$

or

$$\frac{8 + \sqrt{kv}}{8 - \sqrt{kv}} = c_1 e^{8\sqrt{kt}} \quad (c_1 = \pm e^{8\sqrt{kc}})$$

At  $t = 0$ , we are given that  $v = 0$ . This implies  $c_1 = 1$ , and the velocity is given by

$$\frac{8 + \sqrt{kv}}{8 - \sqrt{kv}} = e^{8\sqrt{kt}} \quad \text{or} \quad v = \frac{8}{\sqrt{k}} \tanh 4\sqrt{kt}$$

Note that without additional information, we cannot obtain a numerical value for the constant  $k$  (Bronson and Costa, 2006).

### 4.3.2 Spring Problems

Now an application of second order linear differential equation is given.

The simple spring system shown in Fig. 4.4 consists of a mass  $m$  attached to the lower end of a spring that is itself suspended vertically from a mounting. The system is in its equilibrium position when it is at rest. The mass is set in motion by one or more of the following means: displacing the mass from its equilibrium position, providing it with an initial velocity, or subjecting it to an external force  $F(t)$ .

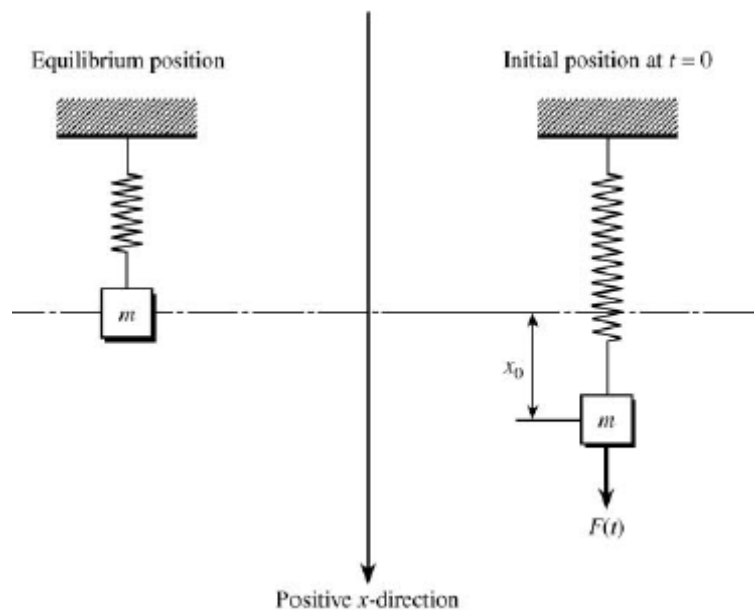

Figure 4.4 Spring from Bronson and Costa (2006)

**Hooke's law:** The restoring force  $F$  of a spring is equal and opposite to the forces applied to the spring and is proportional to the extension (contraction)  $I$  of the spring as a result of the applied force; that is,  $F = -kl$ , where  $k$  denotes the constant of proportionality, generally called the spring constant (Bronson and Costa, 2006).

**Example 4.1** A steel ball weighing 128 lb is suspended from a spring, whereupon the spring is stretched 2 ft from its natural length. The applied force responsible for the 2-ft displacement is the weight of the ball, 128 lb. Thus,  $F = -128$  lb. Hooke's law then gives  $-128 = -k(2)$ , or  $k = 64$  lb/ft.

For convenience, we choose the downward direction as the positive direction and take the origin to be the center of gravity of the mass in the equilibrium position. We assume that the mass of the spring is negligible and can be neglected and that air resistance, when present, is proportional to the velocity of the mass. Thus, at any time  $t$ , there are three forces acting on the system: (1)  $F(t)$ , measured in the positive direction; (2) a restoring force given by Hooke's law as  $F_s = -kx, k > 0$ ; and (3) a force due to air resistance given by  $F_a = -a\dot{x}$ ,  $a > 0$ , where  $a$  is the constant of proportionality. Note that the restoring force  $F_s$  always acts in a direction that will tend to return the system to the equilibrium position: if the mass is below the equilibrium position, then  $x$  is positive and  $-kx$  is negative; whereas if the mass is above the equilibrium position, then  $x$  is negative and  $-kx$  is positive. Also note that because  $a > 0$  the force  $F_a$  due to air resistance acts in the opposite direction of the velocity and thus tends to retard, or damp, the motion of the mass (Bronson and Costa, 2006).

It now follows from Newton's second law that  $m\ddot{x} = -kx - a\dot{x} + F(t)$ , or

$$\ddot{x} + \frac{a}{m}\dot{x} + \frac{k}{m}x = \frac{F(t)}{m} \quad (4.6)$$

If the system starts at  $t = 0$  with an initial velocity  $v_0$  and from an initial position  $x_0$ , we also have the initial conditions

$$x(0) = x_0 \quad \dot{x}(0) = v_0$$

The force of gravity does not explicitly appear in Eq. (4.6), but it is present nonetheless. We automatically compensated for this force by measuring distance from the equilibrium position of the spring. If one wishes to exhibit gravity explicitly, then distance must be measured from the bottom end of the natural length of the spring. That is, the motion of a vibrating spring can be given by

$$\ddot{x} + \frac{a}{m}\dot{x} + \frac{k}{m}x = g + \frac{F(t)}{m}$$

if the origin,  $x = 0$ , is the terminal point of the unstretched spring before the mass  $m$  is attached (Bronson and Costa, 2006).



### Problem 4.8

A steel ball weighing 128 lb is suspended from a spring, where upon the spring is stretched 2 ft from its natural length. The ball is started in motion with no initial velocity by displacing it 6 in above the equilibrium position. Assuming no air resistance, find (a) an expression for the position of the ball at anytime  $t$ , and (b) the position of the ball at  $t = \pi/12$  sec.

- (a) The equation of motion is governed by Eq. (4.6). There is no externally applied force, so  $F(t) = 0$ , and no resistance from the surrounding medium, so  $a = 0$ . The motion is free and undamped. Here  $g = 32$  ft/sec<sup>2</sup>,  $m = 128/32 = 4$  slugs, and it follows from Example 4.1 that  $k = 64$  lb/ft. Equation (4.6) becomes  $\ddot{x} + 16x = 0$ . The roots of its characteristic equation are  $\lambda = \pm 4i$ , so its solution is

$$x(t) = c_1 \cos 4t + c_2 \sin 4t \quad (1)$$

At  $t = 0$ , the position of the ball is  $x_0 = -\frac{1}{2}$  ft (the minus sign is required because the ball is initially displaced above the equilibrium position, which is in the negative direction). Applying this initial condition to (1), we find that

$$-\frac{1}{2} = x(0) = c_1 \cos 0 + c_2 \sin 0 = c_1$$

so (1) becomes

$$x(t) = -\frac{1}{2} \cos 4t + c_2 \sin 4t \quad (2)$$

The initial velocity is given as  $v_0 = 0$  ft/sec. Differentiating (2), we obtain

$$v(t) = \dot{x} = 2 \sin 4t + 4c_2 \cos 4t$$

$$\text{whereupon } 0 = v(0) = 2 \sin 0 + 4c_2 \cos 0 = 4c_2$$

Thus,  $c_2 = 0$ , and (2) simplifies to

$$x(t) = -\frac{1}{2} \cos 4t \quad (3)$$

as the equation of motion of the steel ball at any time  $t$ .

(b) At  $t = \pi/12$ ,

$$x\left(\frac{\pi}{12}\right) = -\frac{1}{2} \cos \frac{4\pi}{12} = -\frac{1}{4} \text{ ft}$$

(Bronson and Costa, 2006).

### Problem 4.9

A 128-lb weight is attached to a spring having a spring constant of 64 lb/ft. The weight is started in motion with no initial velocity by displacing it 6 in above the equilibrium position and by simultaneously applying to the weight an external force  $F(t) = 8 \sin 4t$ . Assuming no air resistance, find the subsequent motion of the weight.

Here  $m = 4$ ,  $k = 64$ ,  $a = 0$ , and  $F(t) = 8 \sin 4t$ ; hence, Eq. (4.6) becomes

$$\ddot{x} + 16x = 2 \sin 4t \quad (1)$$

This problem is, therefore, an example of forced undamped motion. The solution to the associated homogeneous equation is

$$x_h = c_1 \cos 4t + c_2 \sin 4t$$

A particular solution is found by the method of undetermined coefficients:  $x_p = -\frac{1}{4} \cos 4t$ . The solution to (1) is then

$$x = c_1 \cos 4t + c_2 \sin 4t - \frac{1}{4} \cos 4t$$

Applying the initial conditions,  $x(0) = -\frac{1}{2}$  and  $\dot{x}(0) = 0$ , we obtain

$$x = -\frac{1}{2}\cos 4t + \frac{1}{16}\sin 4t - \frac{1}{4}t \cos 4t$$

Note that  $|x| \rightarrow \infty$  as  $t \rightarrow \infty$ . This phenomenon is called *pure resonance*. It is due to the forcing function  $F(t)$  having the same circular frequency as that of the associated free undamped system (Bronson and Costa, 2006).

#### 4.4 Electric Circuits

The basic equation governing the amount of current  $I$  (in amperes) in a simple RL circuit (Fig. 4.5) consisting of a resistance  $R$  (in ohms), an inductor  $L$  (in henries), and an electromotive force (abbreviated emf)  $E$  (in volts) is

$$\frac{dI}{dt} + \frac{R}{L}I = \frac{E}{L} \quad (4.7)$$

For an RC circuit consisting of a resistance, a capacitance  $C$  (in farads), an emf, and no inductance (Fig. 4.6), the equation governing the amount of electrical charge  $q$  (in coulombs) on the capacitor is

$$\frac{dq}{dt} + \frac{1}{RC}q = \frac{E}{R} \quad (4.8)$$

The relationship between  $q$  and  $I$

$$I = \frac{dq}{dt} \quad (4.9)$$

(Bronson and Costa, 2006).

#### Problem 4.10

An RL circuit has an emf of 5 volts, a resistance of 50 ohms, an inductance of 1 henry, and no initial current. Find the current in the circuit at any time  $t$ .

Here  $E = 5$ ,  $R = 50$ , and  $L = 1$ ; hence (4.7) becomes

$$\frac{dI}{dt} + 50I = 5$$

This equation is linear; its solution is

$$I = ce^{-50t} + \frac{1}{10}$$

At  $t = 0$ ,  $I = 0$ ; thus,  $0 = ce^{-50t} + \frac{1}{10}$ , or  $c = -\frac{1}{10}$ . The current at any time  $t$  is then

$$I = -\frac{1}{10}e^{-50t} + \frac{1}{10}$$

The quantity  $-\frac{1}{10}e^{-50t}$  in (1) is called the transient current, since this quantity goes to zero ("dies out") as  $t \rightarrow \infty$ . The quantity  $\frac{1}{10}$  in (1) is called the steady-state current. As  $t \rightarrow \infty$ , the current  $I$  approaches the value of the steady-state current (Bronson and Costa, 2006).

#### **Problem 4.11**

An RC circuit has an emf given (in volts) by  $400 \cos 2t$ , a resistance of 100 ohms, and a capacitance of  $10^{-2}$  Farad. Initially there is no charge on the capacitor. Find the current in the circuit at any time  $t$

We first find the charge  $q$  and then use (4.9) to obtain the current. Here,  $E = 400 \cos 2t$ ,  $R = 100$ , and  $C = 10^{-2}$ ; hence (4.8) becomes.

$$\frac{dq}{dt} + q = 4 \cos 2t$$

This equation is linear, and its solution is (two integrations by parts are required)

$$q = ce^{-t} + \frac{8}{5} \sin 2(t) + \frac{4}{5} \cos 2t$$

At  $t = 0$ ,  $q = 0$ ; hence,

$$0 = ce^{-(0)} + \frac{8}{5} \sin 2(0) + \frac{4}{5} \cos 2(0) \text{ or } c = -\frac{4}{5}$$

Thus

$$q = -\frac{4}{5}e^{-t} + \frac{8}{5} \sin 2t + \frac{4}{5} \cos 2t$$

and using (4.9), we obtain

$$I = \frac{dq}{dt} = \frac{4}{5}e^{-t} + \frac{16}{5} \cos 2t - \frac{8}{5} \sin 2t$$

(Bronson and Costa, 2006).

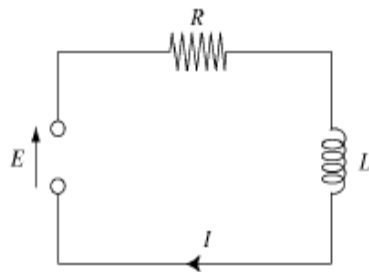

**Figure 4.5 RL Circuit from Bronson and Costa (2006)**

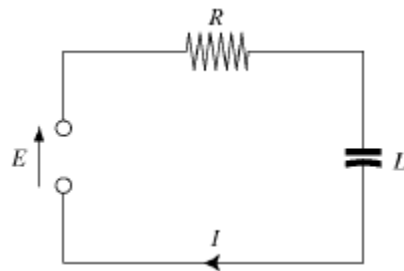

**Figure 4.6 RC Circuit from Bronson and Costa (2006)**

Electrical problems with first-order differential equations are given above. Now electrical problems with second-order differential equations are given below.

The simple electrical circuit shown in Fig. 4.7 consists of a resistor  $R$  in ohms; a capacitor  $C$  in farads; an inductor  $L$  in henries; and an electromotive force (emf)  $E(t)$  in volts, usually a battery or a generator, all

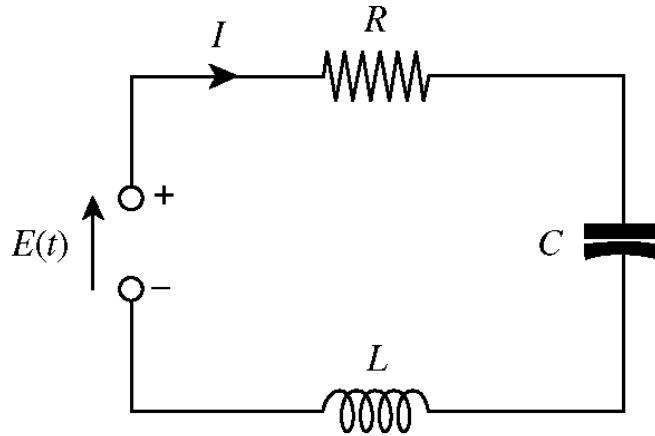

Figure 4.7 Simple electrical circuit from Bronson and Costa (2006)

connected in series. The current  $I$  flowing through the circuit is measured in amperes and the charge  $q$  on the capacitor is measured in coulombs.

**Kirchhoff's loop law:** The algebraic sum of the voltage drops in a simple closed electric circuit is zero (Bronson and Costa, 2006).

It is known that the voltage drops across a resistor, a capacitor, and an inductor are respectively  $RI$ ,  $(1/C)q$ , and  $L(dl/dt)$  where  $q$  is the charge on the capacitor. The voltage drop across an emf is  $-E(t)$ . Thus, from Kirchhoff's loop law, we have

$$RI + L \frac{dI}{dt} + \frac{1}{C}q - E(t) = 0 \quad (4.10)$$

The relationship between  $q$  and  $I$  is

$$I = \frac{dq}{dt} \quad (4.11)$$

Substituting these values into (4.10), we obtain

$$\frac{d^2q}{dt^2} + \frac{R}{L} \frac{dq}{dt} + \frac{1}{LC} q = \frac{1}{L} E(t) \quad (4.12)$$

The initial conditions for  $q$  are

$$q(0) = q_0 \left. \frac{dq}{dt} \right|_{t=0} = I(0) = I_0$$

To obtain a differential equation for the current, we differentiate Eq. (4.10) with respect to  $t$  and then substitute Eq. (4.11) directly into the resulting equation to obtain

$$\frac{d^2I}{dt^2} + \frac{R}{L} \frac{dI}{dt} + \frac{1}{LC} I = \frac{1}{L} \frac{dE(t)}{dt}$$

The first initial condition is  $I(0) = I_0$ . The second initial condition is obtained from Eq. (4.10) by solving for  $dI/dt$  and then setting  $t = 0$ . Thus,

$$\left. \frac{dI}{dt} \right|_{t=0} = \frac{1}{L} E(0) - \frac{R}{L} I_0 - \frac{1}{LC} q_0 \quad (4.13)$$

An expression for the current can be gotten either by solving Eq. (4.13) directly or by solving Eq. (4.12) for the charge and then differentiating that expression (Bronson and Costa, 2006).

#### **Problem 4.12**

An RCL circuit connected in series has  $R = 180$  ohms,  $C = 1/280$  farad,  $L = 20$  henries, and an applied voltage  $E(t) = 10 \sin t$ . Assuming no initial charge on the capacitor, but an initial current of 1 ampere at  $t = 0$  when the voltage is first applied, find the subsequent charge on the capacitor.

Substituting the given quantities into Eq. (4.12), we obtain

$$\ddot{q} + 9\dot{q} + 14q = \frac{1}{2} \sin t$$

The general solution to the associated homogeneous equation

$x + 9x + 14x = 0$  is

$$q_h = c_1 e^{-2t} + c_2 e^{-7t}$$

Using the method of undetermined coefficients, we find

$$q_p = \frac{13}{500} \sin t - \frac{9}{500} \cos t$$

The general solution of (1) is therefore

$$q = q_h + q_p = c_1 e^{-2t} + c_2 e^{-7t} + \frac{13}{500} \sin t - \frac{9}{500} \cos t$$

Applying the initial conditions  $q(0) = 0$  and  $\dot{q}(0) = 1$ , we obtain  $c_1 = 110/500$  and  $c_2 = -101/500$ . Hence,

$$q = \frac{1}{500} (110e^{-2t} - 101e^{-7t} + 13 \sin t - 9 \cos t)$$

(Bronson and Costa, 2006).



## 5 CONCLUSION

Linear ordinary differential equations appear in various fields of science and engineering. So applications of this subject have tried to be given as many as it is possible. Also theoretical methods were given at the second chapter. The theoretical results for the solution of these differential equations are supported by the results of numerical examples in this study.

In conclusion, main aim of this project is to explain linear ordinary differential equations solution methods and indicate its calculation and solution on most widely-used areas as economics and engineering. In this thesis, it is explained and exemplified that applications of linear ordinary differential equations are one of the most commonly used methods while solving problems related to economics that design our investments, or related to biology that examines livings population or generation, or related to falling body problems which has a great research area from a glider to basketball, or related to what not.

This thesis can be considered as a reference on linear ordinary differential equations for scientists working on any experiment.

## REFERENCES

- Asfiji, Isfahane, Dastjerdi and Fakhar**, 2012. Analysis of Economic Growth Differential Equations, International Journal of Business and Behavioral Sciences Vol. 2, No.11.
- Bellman, R.E. and K.L. Cooke**, 1963, Differential-difference equations, Mathematics in Science and Engineering 6 (Academic Press, London).
- Benhabib, J. and A. Rustichini**, 1991, Vintage capital, investment and growth, Journal of Economic Theory 55, 323-339.
- Boucekkine, R., and Licandro, O.**, 1995. Differential-difference equations in economics : On the numerical solution of vintage capital growth markets. Madrid: Universidad Carlos III de Madrid, Departamento de Estadística y Econometría.
- Boyce, W.E and Diprima, R. C.**, 2001, Elementary Differential Equations and Boundary Value Problems (7th ed). New York: John Wiley&Sons.
- Bronson, R., and Costa, G.**, 2006. Schaum's outline of differential equations (3rd ed.). New York: McGraw-Hill.
- Caballero, R.J. and M.L. Hammour**, 1994, The cleansing effects of recessions, American Economic Review 84, 1350-1368.
- Cai, Donghan; Ye, Hui; Gu, Longfei**, 2014. A Generalized Solow-Swan Model. Abstr. Appl. Anal. Special Issue (2013), 1--8.
- Cesare, L. and Sportelli, M.**, 2005. A dynamic IS-LM model with delayed taxation revenues. Chaos, Solitons & Fractals, 25: 233-244
- Coale, A.**, 1972. The growth and structure of human populations: A mathematical investigation. Princeton, N.J.: Princeton University Press.
- Collatz, L.**, 1986. Differential equations : an introduction with applications. Chichester [West Sussex]: Wiley.

**Çengel, Y., and Palm, W.,** 2013. Differential equations for engineers and scientists. New York, NY: McGraw Hill.

**Edwards, C. and Penney, D.,** 1996, Elementary Differential Equations (6th ed).

**New Jersey: Pearson Education..Kara, E.,** 2015. Solution of Differential Equations Using Nonstandard Finite Difference Methods

**Mankiw NG, Romer D, Weil D.** A Contribution to the Empirics of Economic Growth. Quarterly Journal of Economics. 1992;107(May):407-437

**Ross, S. L.,** 2004, Differential Equations, John Wiley & Sons Inc., 808p.

**Schoen, R. and Y.J. Kim.,** 1994a. Cyclically stable populations. Mathematical Population Studies 4:283-295.

**Shawagfeh, N., & Kaya, D.,** (2003). Comparing numerical methods for the solutions of systems of ordinary differential equations. Applied Mathematics Letters 17 (2004), 323-328.

**Sibly, R. M., and Hone, J.,** 2002. Population growth rate and its determinants: an overview. Philosophical Transactions of the Royal Society B: Biological Sciences, 357(1425), 1153–1170.

**Solow, R., J. Tobin, C. Von Weizsacker and M Yaari,** 1966, Neoclassical growth with fixed factor proportions, Review of Economic Studies 33, 79-115.

**Tuljapurkar, S.,** 1985. Population dynamics in variable environments: Vi cyclical environments.

**Weir, M., and Joel Hass,** 2010. Thomas' calculus (12th ed.). Boston: Pearson Addison Wesley.

**Whitehead, A.,** 1958. An introduction to mathematics. New York: Oxford University Press.

## **CURRICULUM VITEA**

My name is Cansu Ayvaz. I was born in 1989. I live in Izmir since I was born. I finished Izmir Yunus Emre Anadolu High School. I graduated from Department of Mathematics of Yasar University in 2012. In 2013 spring term, I started to my Master's Degree in Yasar University. I study on Applied Mathematics. Firstly I worked as a teacher in Mavi Ege College in a short time. Then I have worked as a teacher in İzmir Health Collage since September 2014.